

Fischer Panda

Operation manual - Part 1

Description of the generator and operation manual



Panda PMS 8 „Mini“

Super silent technology

120 V - 60 Hz / 8kW

Icemaster Fischer Panda



since 1977
Icemaster GmbH



since 1978
Fischer Marine
Generators



since 1988
Conclusion Fischer -
Icemaster GmbH



since 1988
100 % water cooled
Panda generators



since 1988
Panda Vehicle
Generators

Fischer Panda

FISCHER GENERATORS have been manufactured since 1978 and are a well-known brand for first class diesel generators with especially effective sound-insulation.

Fischer has been one of the leading manufacturers in respect of quality and know-how during this period.

FISCHER, as the worldwide manufacturer of modern marine diesel generators, developed the Sailor-Silent series for example and produced a GFK sound-insulated capsule as early as 1979 and the basis for new generator technology.

The companies Fischer and Icemaster amalgamated under the direction of Icemaster in 1988, in order to concentrate on the development of new products. Production was moved to Paderborn.

The amalgamation of the two qualified companies led to the development of a complete new programme within a short space of time. The aggregates developed at that time set new technological standards worldwide.

The aggregates became more efficient and powerful than other aggregates in the same nominal performance range, because of the improved cooling. Panda generator demonstrated its superiority in several tests by renowned institutes and magazines during the past years. The patented VCS (voltage Control System) means it can meet all demands including motor speed. The start-booster (ASB) means Panda generators meet the highest demands in respect of voltage stability and starting values. A Panda generator, with the same drive motor, produces 15% more effective output than the majority of conventional generators. This superiority in efficiency also ensures a fuel saving to the same extent.

The 100% water-cooled Panda Aggregate are currently manufactured in the performance range from 2 to 100 kW in various versions. Fast running motors are preferred for performances up to approx 30 kW (Nominal speed 3000 rpm). The heavier slow runners are preferred for the higher range. The fast running aggregates have proved themselves many times for many uses, that they meet the demands in quality of yachts and vehicles, and offer space and weight saving of 50% compared to slow running generators.

In addition to the Panda series, Icemaster also supply the super compact high-tech sound-insulated battery charging aggregate from the DC/AC Panda AGT series, which is a very interesting solution for the production of mobile power.

The new HTG-alternators ensure that a charging rate of 285 amps is achieved that was scarcely thought possible for this compact construction. This alternator replaces a separate shipboard generators (constant 230 volts AC with up to 3500 kW from the main machine)

ICEMASTER GmbH, 33104 Paderborn, reserves all rights regarding text and graphics. Details are given to the best of our knowledge. No liability is accepted for correctness. Technical modifications for improving the product without previous notice may be undertaken without notice. Before installation, it must be ensured that the Pictures, diagrams and related material are applicable to the aggregate supplied. Enquiries must be made in case of doubt.

CALIFORNIA

Proposition 65 Warning

Diesel engine exhaust and some of its constituents are known to the State of California to cause cancer, birth defects, and other reproductive harm.



Attention, Important Directions regarding Operation!

1. The installation certificate must be completed when taken into use, and certified by a signature.
2. The installation certificate must be despatched within two weeks of use to ICEMASTER.
3. The official guaranty confirmation will be completed by ICEMASTER after receipt and sent to the customer.
4. A guaranty must be shown to make any claims.

Claims against the guaranty will not be accepted if the above said instructions are not, or only partially, carried out.

Manufacturer declaration in terms of the machine guideline 98/37/EG .

The generator is in such a way developed that all assembly groups correspond to the CE guidelines. If machine guideline 98/37/EG is applicable, then it is forbidden to bring the generator into operation until it has been determined that the system into which the generator is to be installed in also corresponds to the regulations of the machine guideline 98/37/EG. This concerns among other things the exhaust system, cooling system and the electrical installation.

The evaluation of the "protection against contact" can only be accomplished in connection with the respective system. Likewise among other things responsibility for correct electrical connections, a safe ground wire connection, foreign body and humidity protection, protection against humidity due to excessive condensation as well as the overheating through appropriate and inappropriate use in its installed state on the respective machine lies within the responsibility of those who undertake installation of the generator in the system.

Technical Support per Internet: info@fischerpanda.com

Safety Instructions



The electrical Installations may only be carried out by trained and tested personnel!

The generator may not be taken into use with the cover removed.

The rotating parts (belt-pulley, belts, etc) must be so covered and protected do that there is no danger to life and body!

If a sound insulation covering must be produced at the place of installation, then well-placed signs must show that the generator can only be switched on with a closed capsule.

All servicing-, maintenance or repair work may only carried out, when the motor is not running.

Electrical voltages above 48 volts (battery chargers greater than 36 volts) are always dangerous to life). The rules of the respective regional authority must be adhered to. Only an electrician may carry out installation of the electrical connections for safety reasons.

Protective Conductor:

The generator is „earthed " as standard (The centre and earth are connected by means of a bridge in the generator terminal box). This is a basic safety function, which offers basic safety as long as no other component has been installed. It is, above all, conceived for supply and an eventual test run.

This "earth" (PEN) is only effective, if all parts of the electrical system is earthed, and has a common “potential”. The bridges can be removed, if this is required for technical reasons and another protection system has been installed.

The full voltage is exploited at the AC control box, when the generator is run. It must therefore be ensured that the control box is closed and cannot be tampered with, if the generator is running.

The battery must always be disconnected, if work on the generator or electrical system is to be carried out, so that the generator cannot be unintentionally started.

It is not allowed to disconnect the battery during operation!

After the generator has stopped the battery can be disconnected!

Switch off all consumers when working on the generator

All consumers must be disconnected, in order to avoid damages to the devices. In addition the semi conductors in the AC control box must be disconnected in order to avoid the boat capacitors being activated. The minus pole of the battery ought to be removed.

Capacitors are required to run the generator. These have two varying functions:

- A) The working capacitors
- B) The (Booster) capacitors

Both Groups are located in a separate AC-Control box.

Capacitors are electrical stores. There could be a residual of high electrical current at the contacts for a period disconnection from the circuit. The contacts may not be touched for safety reasons, If the capacitors are to be exchanged or checked, then a short circuit between the contacts should be made so that the stored energy is discharged.

If the generator is switched off in the normal manner, the working capacitors are automatically discharged by means of the windings. The booster capacitors are discharged by means of internal discharge resistors.

All capacitors must be short-circuited before work is carried out on the AC-Control box for safety reasons.

Table of contents

A	The Panda Generator	3
	A.1 Description of the Generator	3
	A.1.1 Right Side View	3
	A.1.2 Left Side View	4
	A.1.3 Front View	5
	A.1.4 Back View.....	6
	A.1.5 View from above.....	7
	A.2 Details of functional units	8
	A.2.1 Remote control panel	8
	A.2.2 Components of Cooling System (Seawater)	9
	A.2.3 Components of Cooling System (Freshwater)	10
	A.2.4 Components of the fuel system	14
	A.2.5 Components of combustion air.....	16
	A.2.6 Components of the electrical system	19
	A.2.7 Sensors and switches for operating surveillance	22
	A.2.8 Components of the oil circuit	24
	A.2.9 External components.....	26
	A.3 Operation manual	27
	A.3.1 Preliminary remark	27
	A.3.2 Daily routine checks before starting	28
	A.3.3 Starting Generator	29
	A.3.4 Stopping the Generator	30
	A.3.5 Starting the Generator by a „Failure bypass switch“	30

A. The Panda Generator

A.1 Description of the Generator

A.1.1 Right Side View

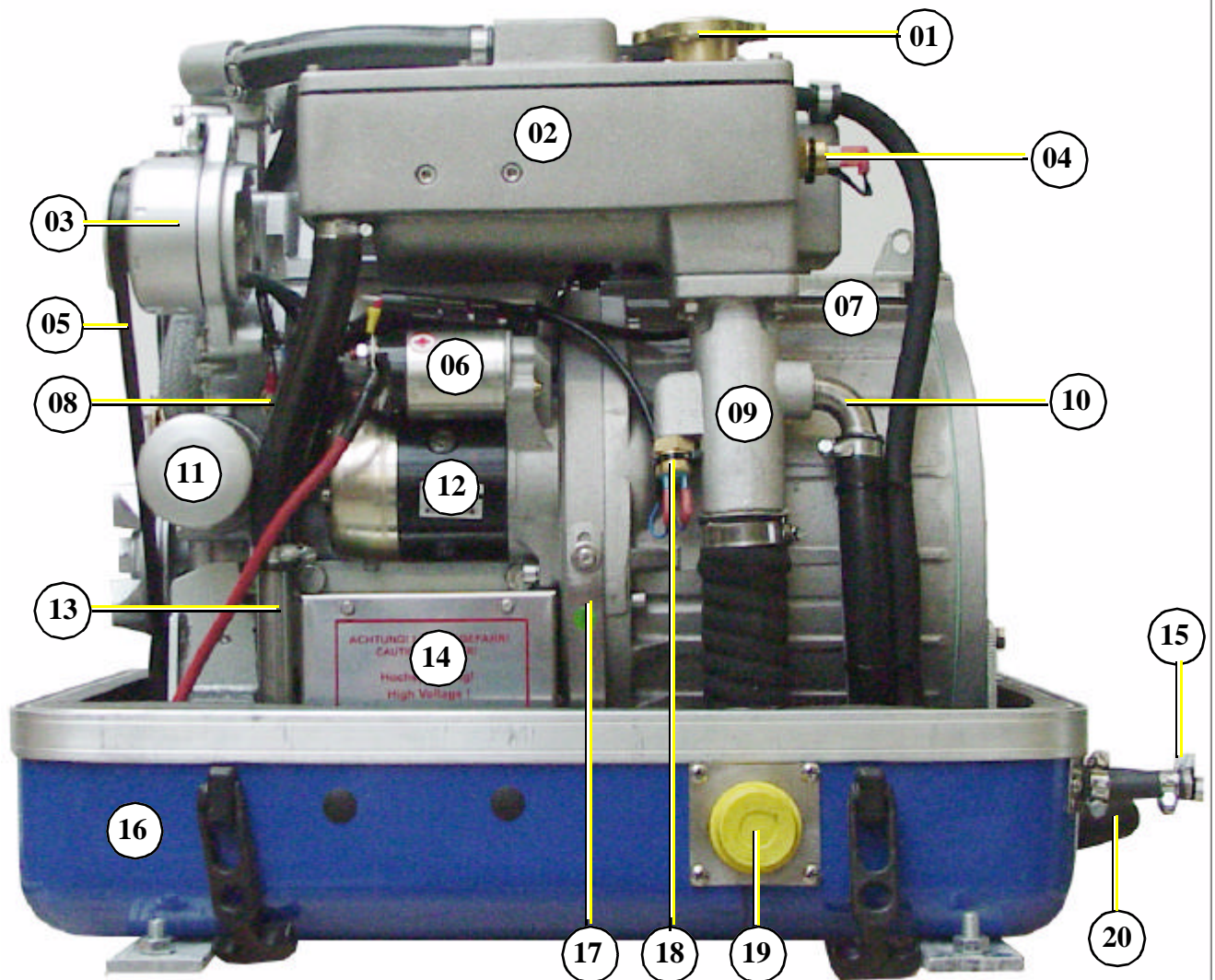

- | | |
|---|--|
| 01. Cooling water filler neck | 11. Engine oil filter |
| 02. Water-cooled exhaust manifold | 12. Starter motor |
| 03. 12V DC-alternator | 13. Cooling water backflow pipe |
| 04. Exhaust manifold thermo-switch | 14. Generator Klemmkasten |
| 05. V-belt for DC-alternator and cooling water pump | 15. Connection for external cooling water expansion tank |
| 06. Magnetic switch for starter motor | 16. Sound cover - base part |
| 07. Generator housing with coil | 17. Engine connecting flange |
| 08. Oil pressure switch | 18. Exhaust thermo-switch |
| 09. Exhaust connection | 19. Exhaust hose connection |
| 10. Injector for cooling water | 20. Connection for external ventilation valve |

A.1.2 Left Side View

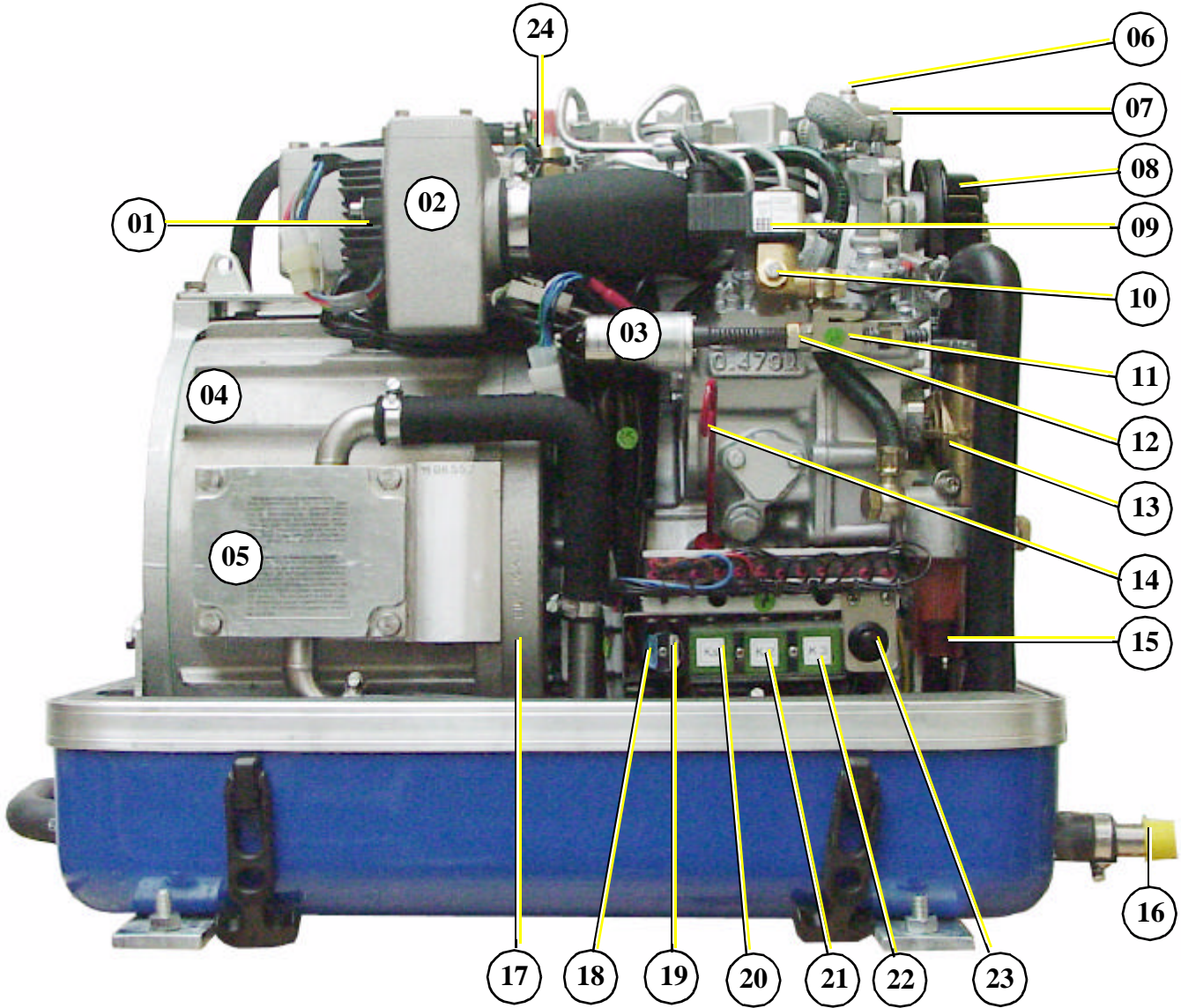

- | | |
|---|--------------------------------------|
| 01. Charge control for DC-alternator | 13. Seawater pump |
| 02. Air suction housing with air filter | 14. Oil dipstick |
| 03. Actuator for speed control | 15. Fuel filter with water separator |
| 04. Generator housing with coil | 16. Seawater inlet |
| 05. Cooling water connection block | 17. Engine connecting flange |
| 06. Ventilation screw thermostat housing | 18. Flat fuse 15Amps (blue) |
| 07. Ventilation screw internal cooling water pump | 19. Flat fuse 25Amps (white) |
| 08. Pulley for internal cooling water pump | 20. Starter relay Ks |
| 09. Fuel solenoid valve | 21. Pre-glow relay (glow plugs) K2 |
| 10. Ventilation screw fuel solenoid valve | 22. Fuel pump start relay K3 |
| 11. Adjusting screw | 23. Failure bypass switch |
| 12. Stop screw for setting maximum speed | 24. Cylinder head thermo-switch |

A.1.3 Front View

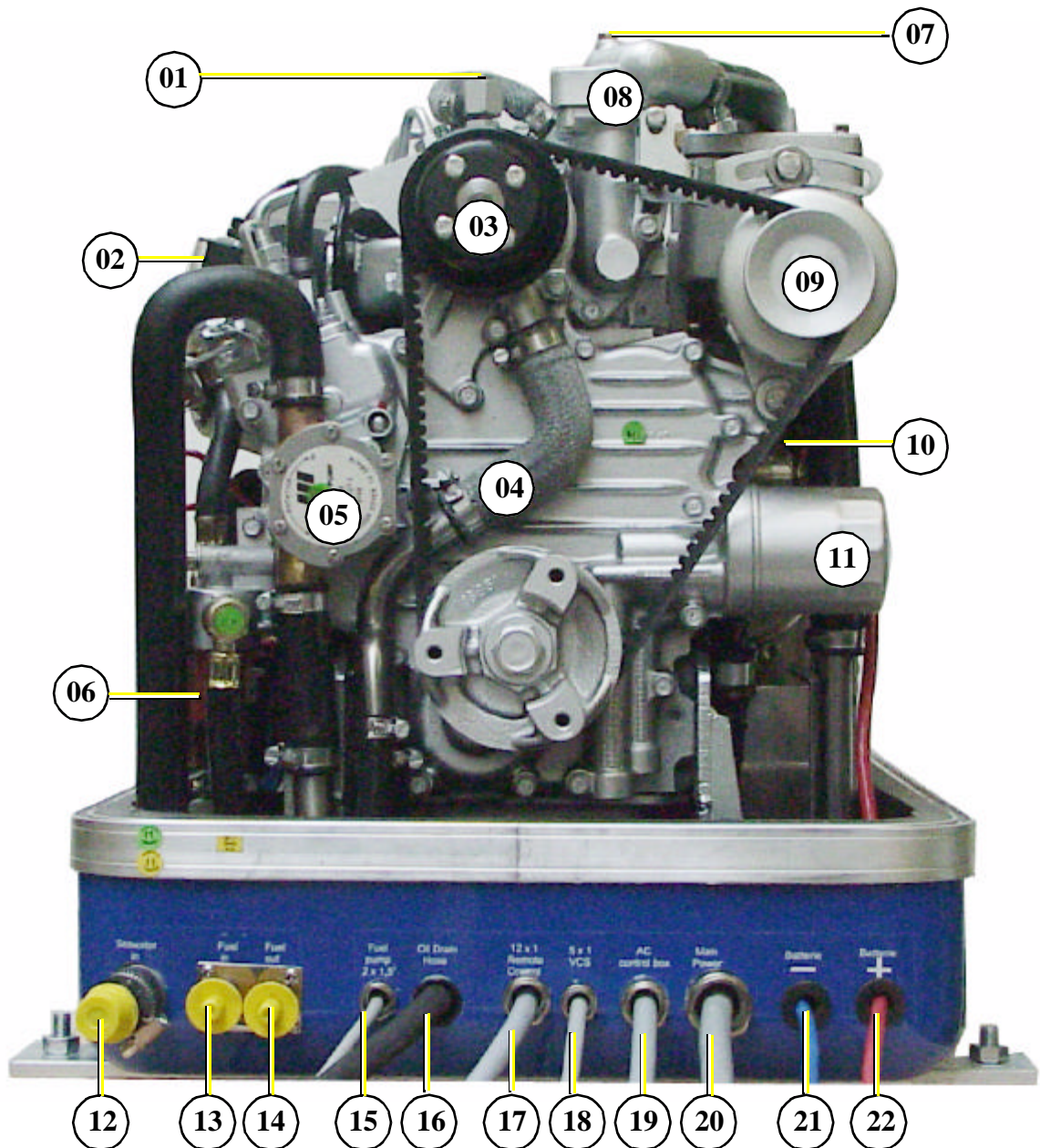

- | | |
|--|--|
| 01. Ventilation screw internal cooling water pump | 12. Seawater inlet |
| 02. Fuel solenoid valve | 13. Fuel intake connection |
| 03. Pulley for internal cooling water pump | 14. Fuel backflow connection |
| 04. Freshwater intake pipe | 15. Fuel pump cable (2x1,5mm ²) |
| 05. Seawater pump | 16. Oil drain hose |
| 06. Fuel filter with water separator | 17. Remote control panel cable (12x1mm ²) |
| 07. Ventilation screw thermostat housing | 18. Electronic Voltage Control cable VCS (5x1mm ²) |
| 08. Thermostat housing with thermostat set | 19. AC-Control box cable |
| 09. 12V DC-alternator | 20. Load |
| 10. V-belt for DC-alternator and internal cooling water pump | 21. Battery minus (-) |
| 11. Engine oil filter | 22. Battery plus (+) |

A.1.4 Back View

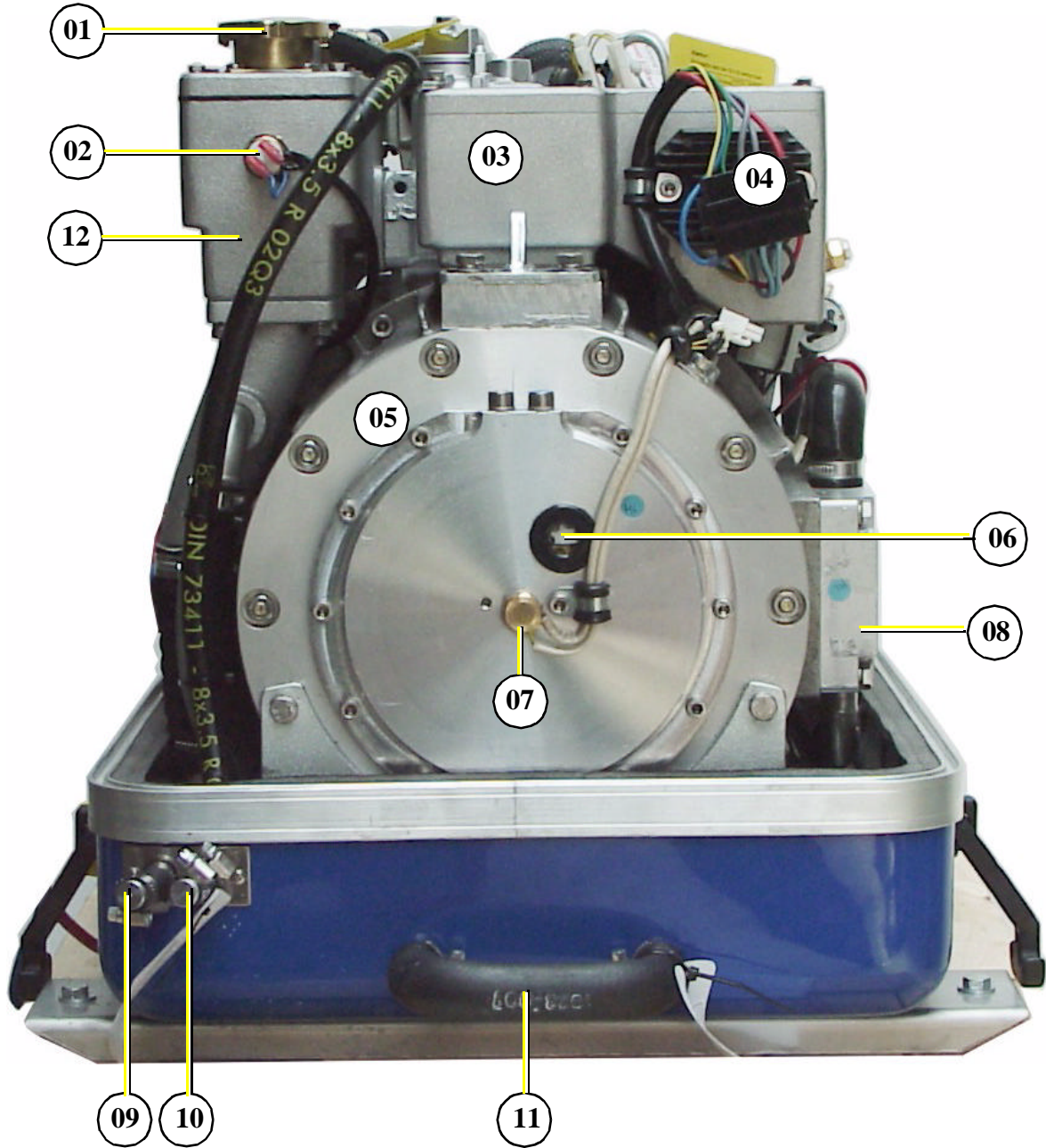

- | | |
|---|--|
| 01. Cooling water filler neck | 07. Thermo switch at oil cooled bearing |
| 02. Exhaust manifold thermo-switch | 08. Cooling water connection block |
| 03. Air suction housing with air filter | 09. Intake external cooling water expansion tank |
| 04. Charge control for DC-alternator | 10. Backflow external cooling water expansion tank |
| 05. Generator front plate | 11. External ventilation valve connection |
| 06. Oil flow glas | 12. Water-cooled exhaust manifold |

A.1.5 View from above

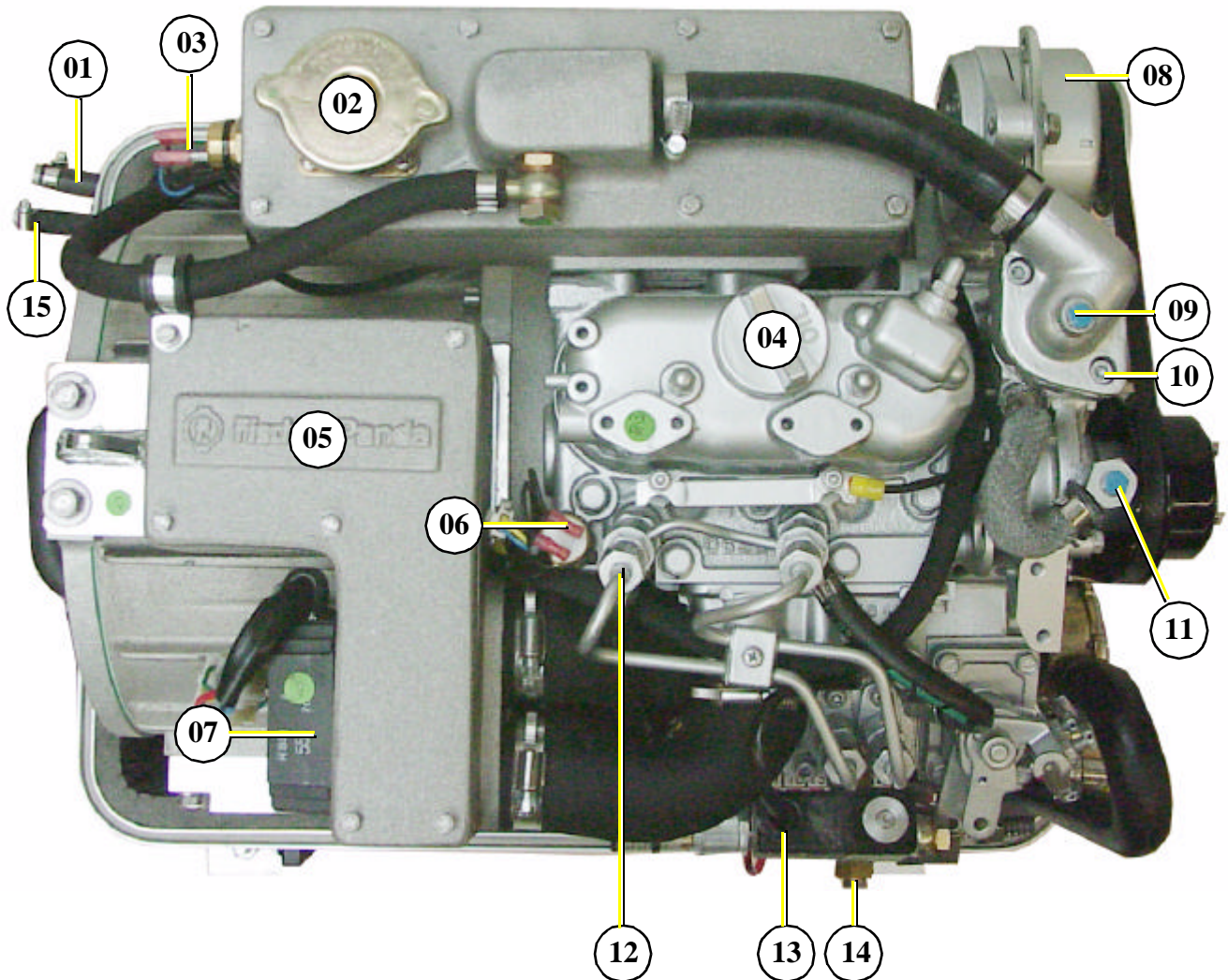

- 01. Intake external cooling water expansion tank
- 02. Cooling water filler neck
- 03. Exhaust manifold thermo-switch
- 04. Engine oil filler neck
- 05. Air suction housing with air filter
- 06. Cylinder head thermo-switch
- 07. Charge control for DC-alternator
- 08. 12V DC-alternator

- 09. Thermostat housing with thermostat set
- 10. Ventilation screw thermostat housing
- 11. Ventilation screw internal cooling water pump
- 12. Injection nozzle
- 13. Fuel solenoid valve
- 14. Ventilation screw fuel solenoid valve
- 15. Backflow external cooling water expansion tank

A.2 Details of functional units

A.2.1 Remote control panel

The remote control panel is necessary to control the generator and to evaluate the motor/generator properties. The generators will automatically cutout if it does not run as required. The generator may not be run without the remote control panel.

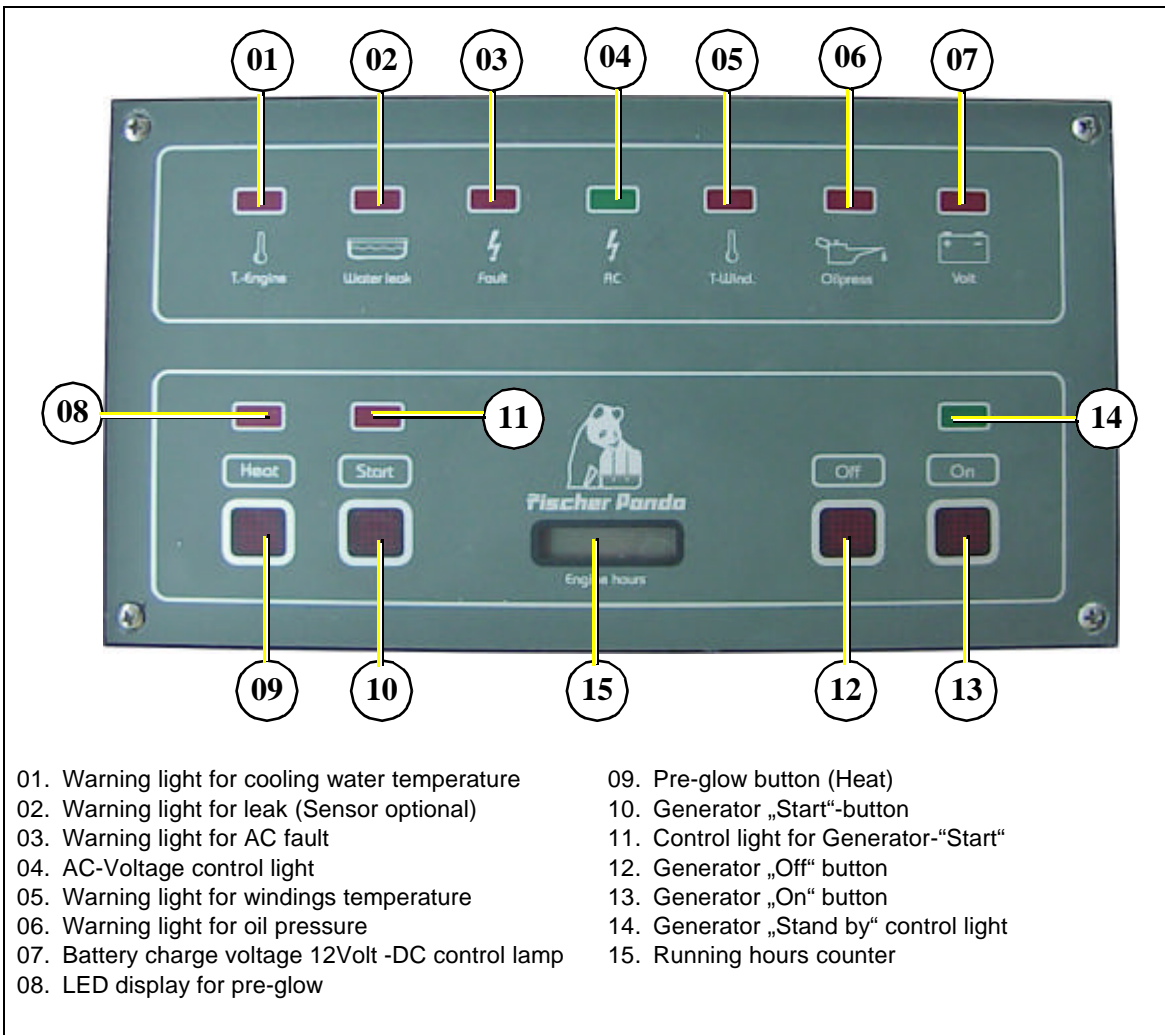

Fig. A.1: Remote control panel

Automatic Start Option

An automatic start option is available as an accessory. This includes a separate control board, which is connected to the main remote control board panel. The Automatic Start Option allows the generator to be started by means of an external signal (i.e Battery Monitor). A speed gauge and a sensor for speed pick-up are additionally necessary in addition to the automatic start option. (See Component Automatic Start)

A.2.2 Components of Cooling System (Seawater)

Seawater intake

The figure shows the supply pipes for the generator. The connection neck for the seawater connection is shown on the left hand side. The cross-section of the intake pipe should be nominally larger than the generator connection.

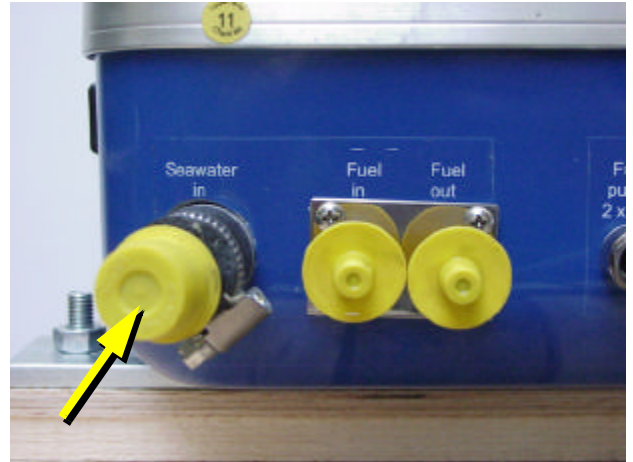

Fig. A.2: Seawater intake

Seawater impeller pump

The seawater pump is fitted with a rubber impeller. This pump is self-inductive. If, for example, you forget to open the sea valve, then you must expect the impeller to be destroyed after a short period of time. It is recommended to store several impellers on board as spare parts.

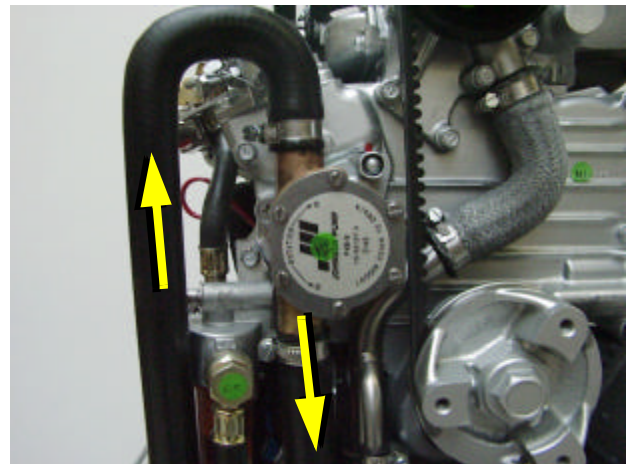

Fig. A.3: Seawater impeller pump

Heat exchanger

Separates the seawater system from the freshwater system.

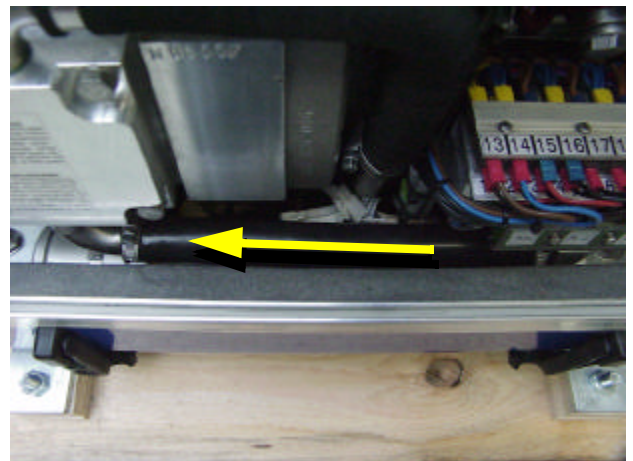
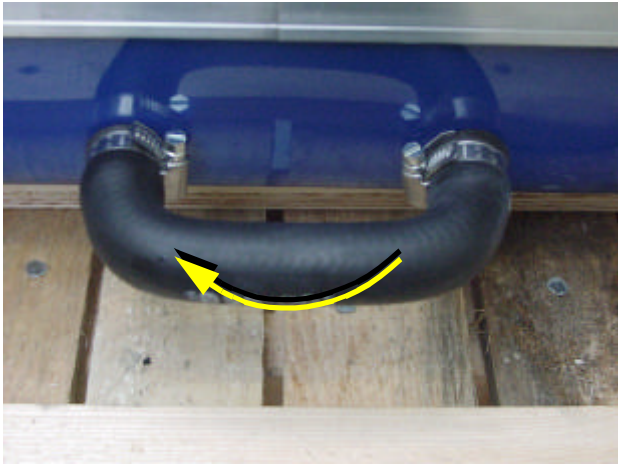

Fig. A.4: Heat exchanger



Ventilation valve

A siphon must be installed if the generator sinks below the water line because of the rocking of the boat, even if it is only for a short period of time. A hosepipe on the generator casing has been produced for this. Both connecting pieces are bridged by a formed piece of hose.

Fig. A.5: Connection external ventilation valve

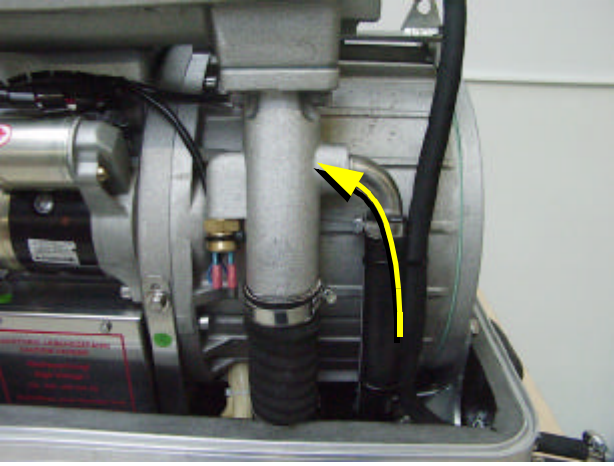

Cooling water injector nozzle

The injection point for the marine generator water-cooled exhaust system is situated at the exhaust connection pieces. The exhaust connections must be regularly checked for signs of corrosion.

Fig. A.6: Cooling water injector nozzle

A.2.3 Components of Cooling System (Freshwater)

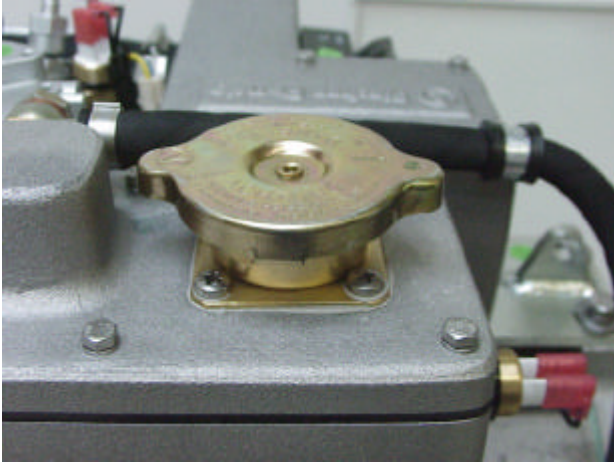

The cooling water filler necks situated at the water-cooled manifold are only used, when the generator is initially started. Since the generator is normally already filled with cooling water, these components are only by the user, if repairs are to be carried out. Topping up with cooling water may only be carried out at the external cooling water compensation tank. Note that the water level in the cooling water compensation tank is only 20% of the volume in a cold state.

Fig. A.7: Cooling water filler neck

Freshwater backflow

The cooling water is fed to the heat exchanger from the water-cooled manifold by means of the pipe shown in the diagram.

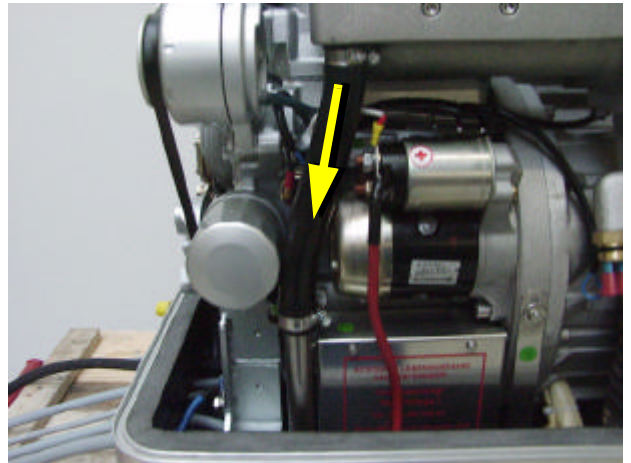

Fig. A.8: Freshwater backflow

Ventilation pipe

The ventilation pipe at the water-cooled exhaust manifold leads to the external expansion tank. This pipe only serves as a ventilation pipe, if both pipes are to be connected to the external expansion tank (ventilation pipe and intake pipe).

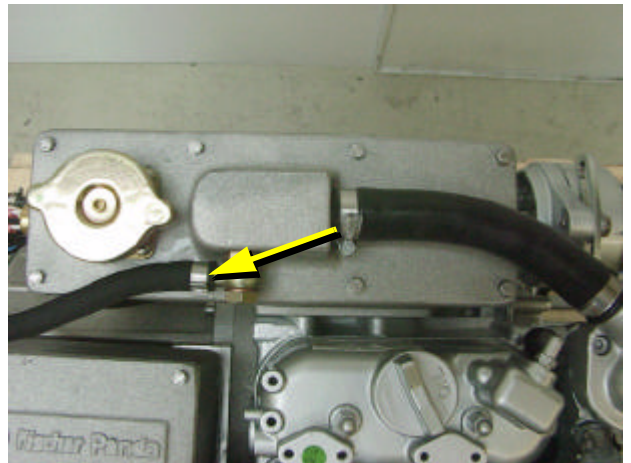

Fig. A.9: Ventilation pipe

Hose connection pieces for the external expansion tank

The external expansion tank is connected by two hose connections. The connecting pieces shown here serves as constant ventilation for the water-cooling system.

In case the external expansion tank is connected with two hoses, the system will ventilate itself. In this case, additional ventilation is only necessary when the generator is initially filled, or if the cooling water is not circulating.

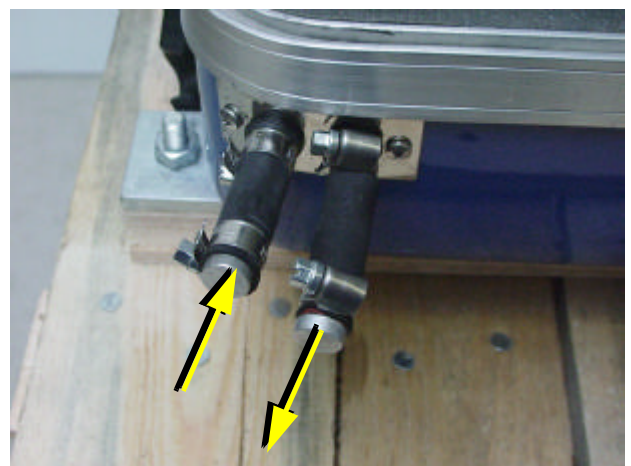
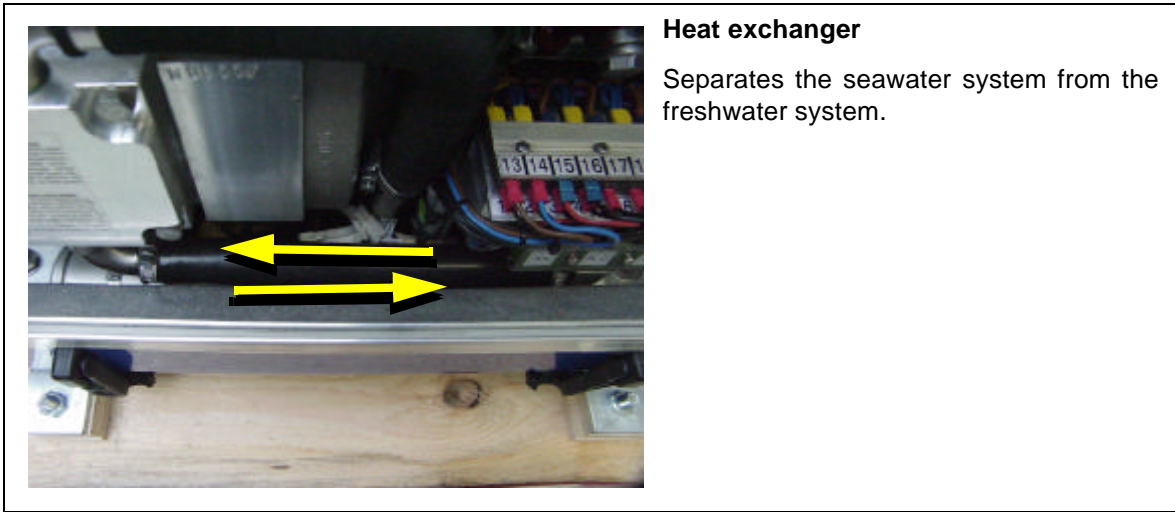
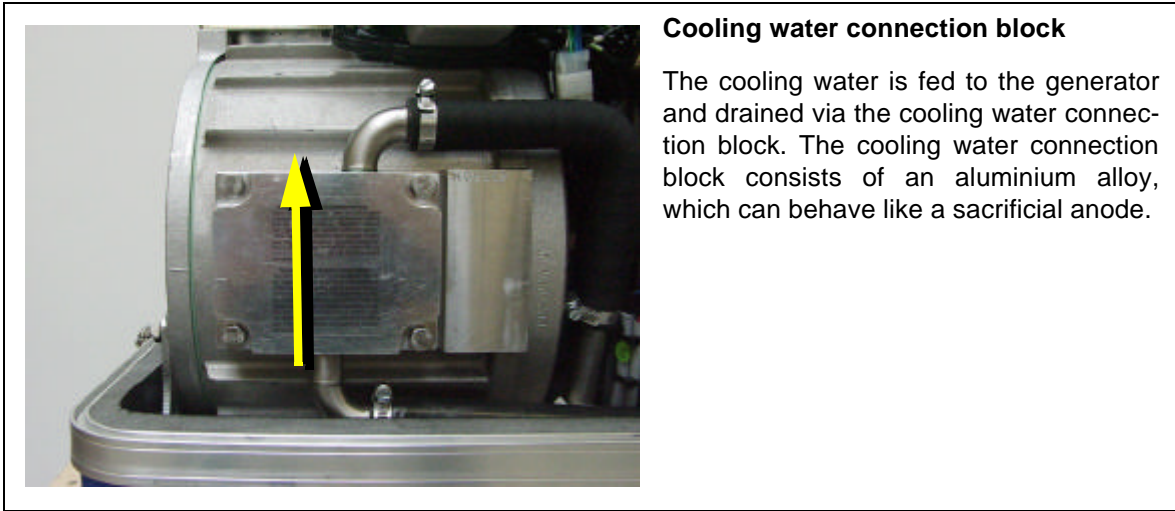

Fig. A.10: External expansion tank

**Heat exchanger**

Separates the seawater system from the freshwater system.

Fig. A.11: Heat exchanger

**Cooling water connection block**

The cooling water is fed to the generator and drained via the cooling water connection block. The cooling water connection block consists of an aluminium alloy, which can behave like a sacrificial anode.

Fig. A.12: Cooling water connection block

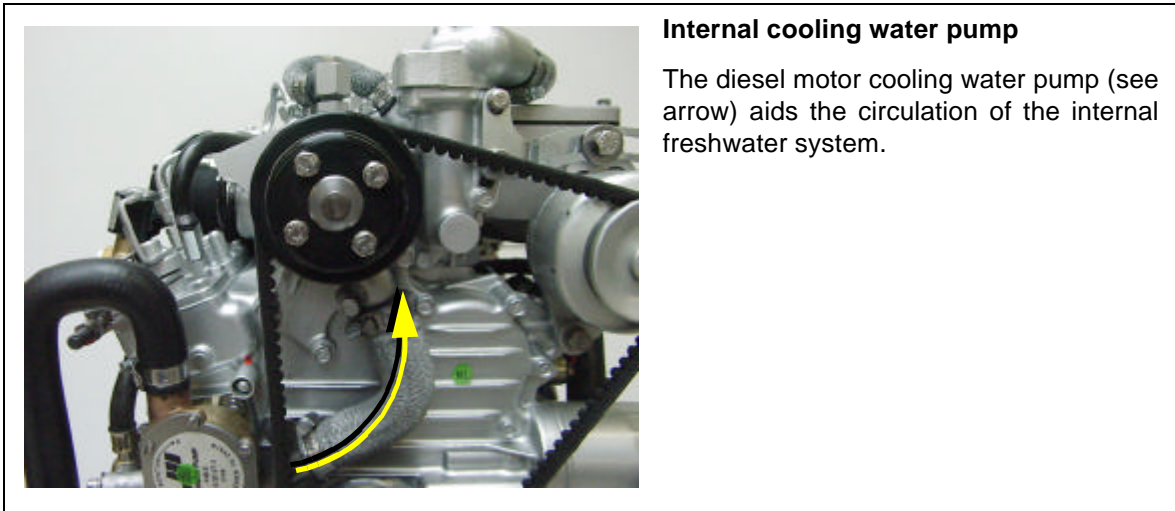
**Internal cooling water pump**

The diesel motor cooling water pump (see arrow) aids the circulation of the internal freshwater system.

Fig. A.13: Internal cooling water pump

Cooling water intake

- A.) To the thermostat housing
- B.) From the external expansion tank

The intake pipe from the external cooling water expansion tank is connected to the point shown with „B“.

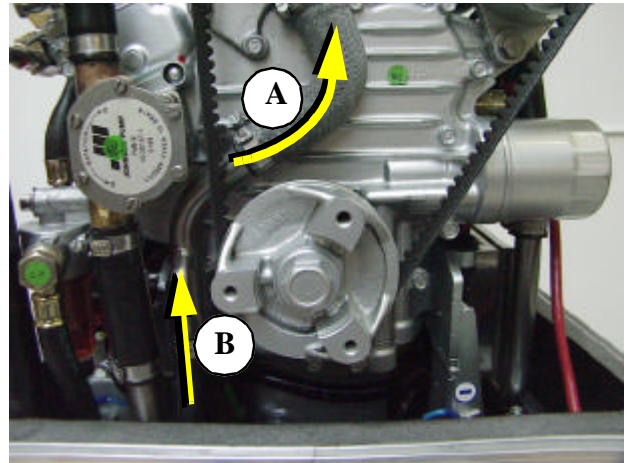

Fig. A.14: Internal cooling water pump

Ventilation screw cooling water pump

The ventilation screw above the cooling water pump casing may not be opened, whilst the generator is running. If this occurs by mistake, air will be drawn through the opening. Extensive ventilation of the whole system is then necessary.

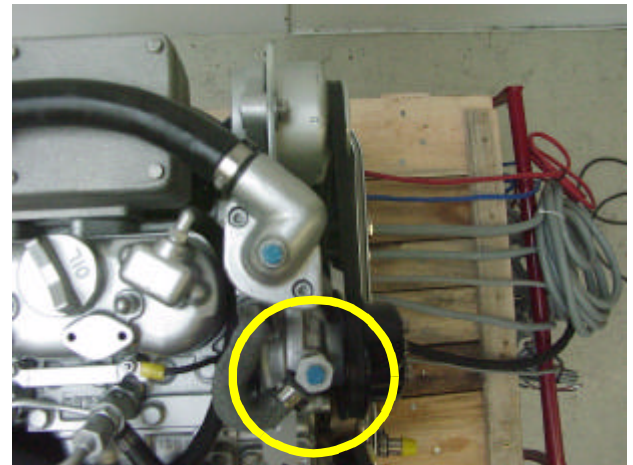

Fig. A.15: Ventilation screw cooling water pump

Ventilation screw thermostat housing

The ventilation screw on the thermostat housing should occasionally be opened for control purposes. Standing machinery should principally carry out ventilating.

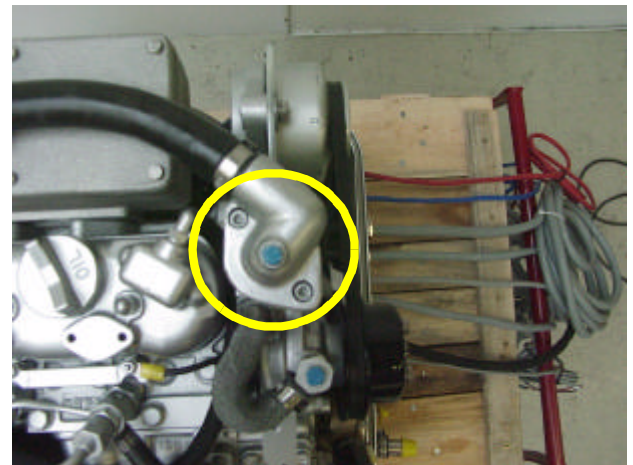
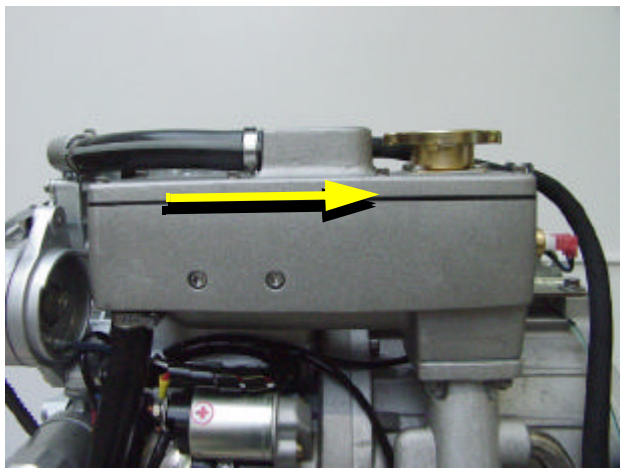

Fig. A.16: Ventilation screw thermostat housing



Water-cooled exhaust manifold

The manifold is cooled by means of the internal cooling system (freshwater). The cooling water filler necks on the casing of the manifold may not be opened. These cooling water necks are only required to fill the motor with cooling water in cases of repair. The normal cooling water controls may only be carried out at the external expansion tank.

Fig. A.17: Water-cooled exhaust manifold

A.2.4 Components of the fuel system



External fuel pump

The Panda generator is always supplied with an external, electrical (12 V of DC) fuel pump. The fuel pump must be always installed in the proximity of the tank. The electrical connections with the lead planned for it are before-installed at the generator. Since the suction height and the supply pressure are limited, it can be sometimes possible that for reinforcement a second pump must be installed.

Fig. A.18: External fuel pump

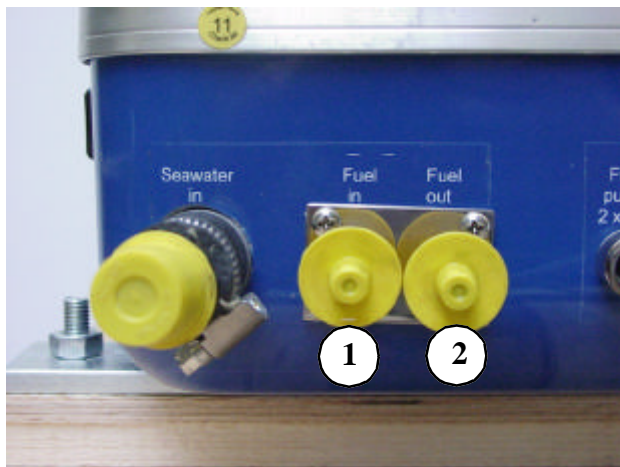

Connecting pieces for the fuel pipe

1. Fuel intake
2. Fuel backflow

Fig. A.19: Fuel connections

Fuel filter

A consequential filtering of fuel is especially important for all marine systems. A fine filter, which is firmly attached to the inside of the sound insulation capsule for the marine version, is supplied on delivery, and loose for other makes. In all cases a further pre-filter with water separator must be installed. See directions for fuel filter installation.

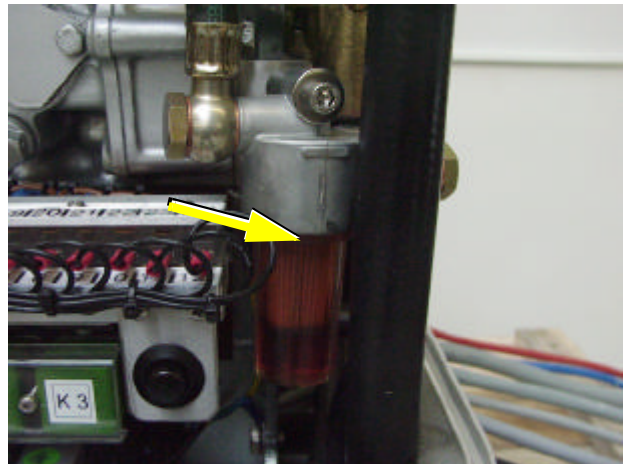

Fig. A.20: Fuel filter

Fuel solenoid valve

The fuel solenoid valve opens automatically if „START“ is pressed on the remote control panel“. The solenoid closes, if the generator is switched to „OFF“ position. It takes a few seconds before the generator stops. If the generator does not start or does not run smoothly (i.e. stutters), or does not attain full speed, then the cause is fore-mostly the solenoid.

- 1) Fuel solenoid valve
- 2) Ventilation screw solenoid valve
- 3) Magnetic coil

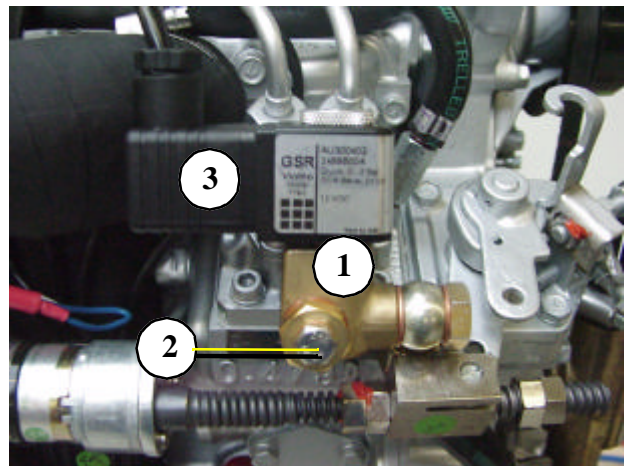

Fig. A.21: Fuel solenoid valve

Injection nozzles

If the engine does not start after the ventilation, the fuel injection lines must be de-aerated individually.

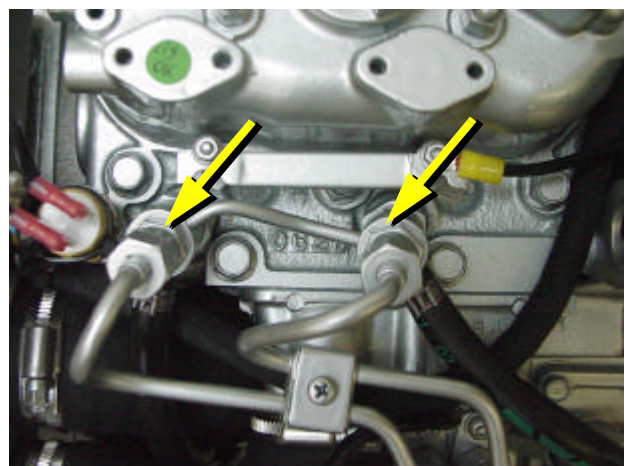
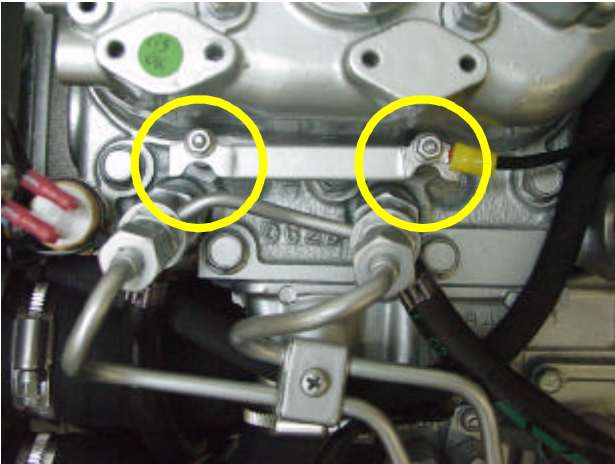

Fig. A.22: Injection nozzles



Glow plugs

The glow plugs serve the pre-chamber for the heating with cold start. The heat-treat fixture must be operated, if the temperature of the generator is under 16°C. This is practically with each start the case. The heat-treat fixture may be held down also during start and favoured the starting procedure.

Fig. A.23: Glow plugs

A.2.5 Components of combustion air



Ansaugluftzufuhr am Gehäuse

The sound cover for the marine generator is normally provided at the lower surface with drillings, through which the combustion air can influx.

It must be consistently paid attention that the generator is installed in such a way that from down no water can arrive into the proximity of these air openings. (minimum distance 150 mm)

Fig. A.24: Combustion air intake

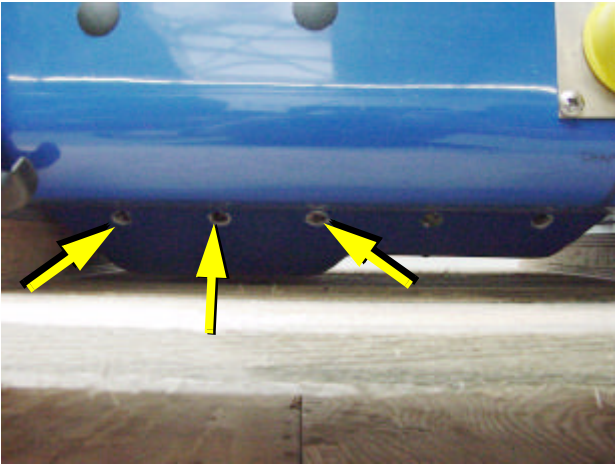

Drillings for combustion air at the sound cover

Drillings at the lower surface of the sound cover serve the admission of fresh air for the entrance. It must be safe that no sea-water or other water can come into this range of this openings. If air is sucked in through these openings, water can penetrate also into the sound cover.

Fig. A.25: Sound cover drillings

Air suction housing with 12V DC charge control

The shown air suction housing shows the 12V DC charge control (pos. 2) at the exterior. This charge control is to be checked, if the 12V DC voltage is not correct.

If the cover (pos. 1) is removed, the inside of the air suction housing becomes visible. In these air suction housings is a filter element. At the marine version the filter is normally not changed. It should be checked once in a while.

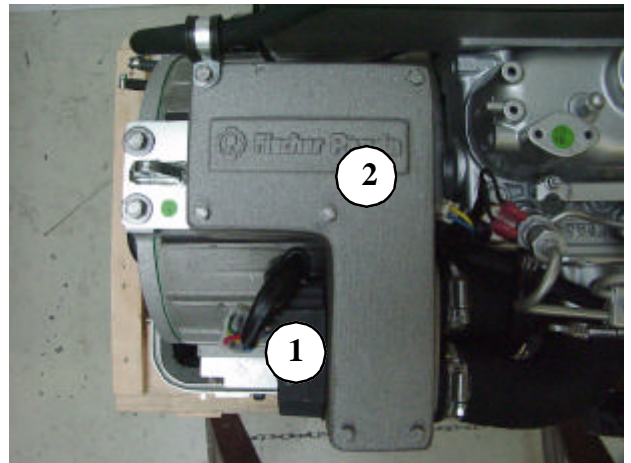

Fig. A.26: Air suction housing

Air suction housing with air filter set

The figure shows the air filter element in the air suction housing. However the return pipe of the crank case exhaust flows also into the air suction housing, it can be faced with older generators and/or with engines on high running time that oil vapors affect the air filter. Therefore an check is advisable once in a while.

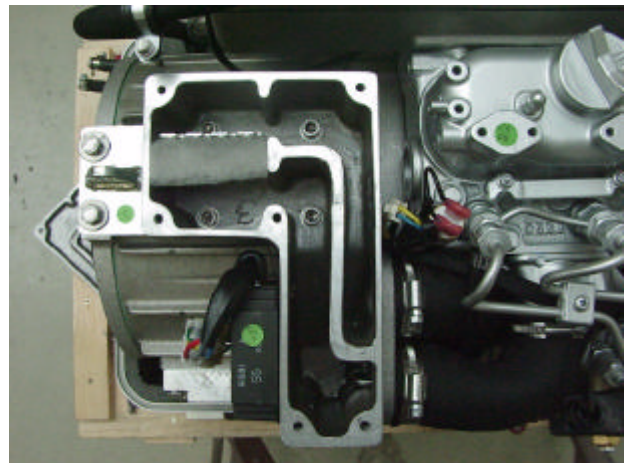

Fig. A.27: Air filter set

Combustion chamber intake elbow

The figure shows the induction elbow at the combustion engine. At the front of this induction elbow you can see the hose connection between air suction housings and induction elbow. The air filter must be checked, if this hose pulls together at operation.

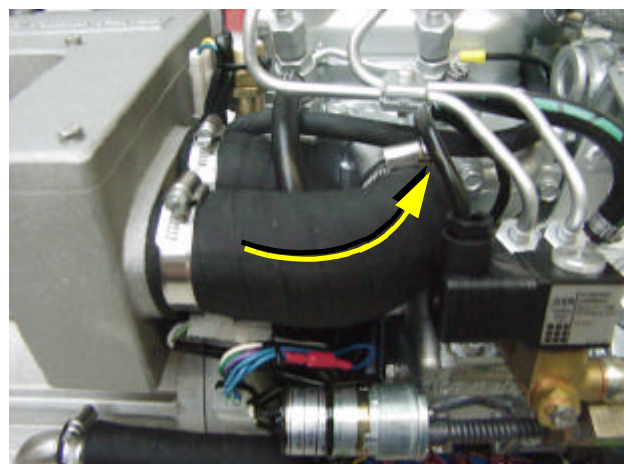

Fig. A.28: Combustion chamber intake elbow

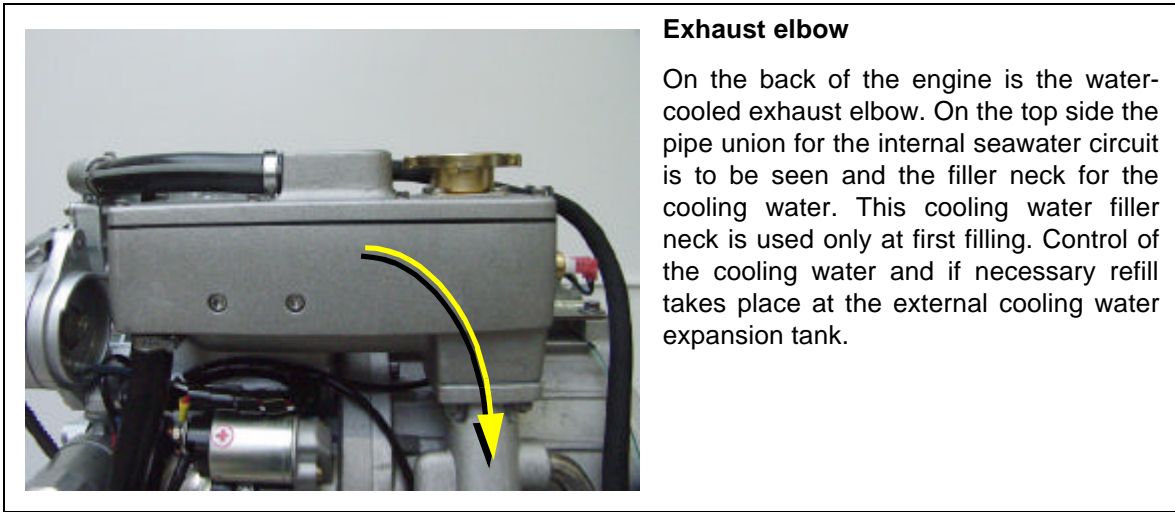

Fig. A.29: Exhaust elbow

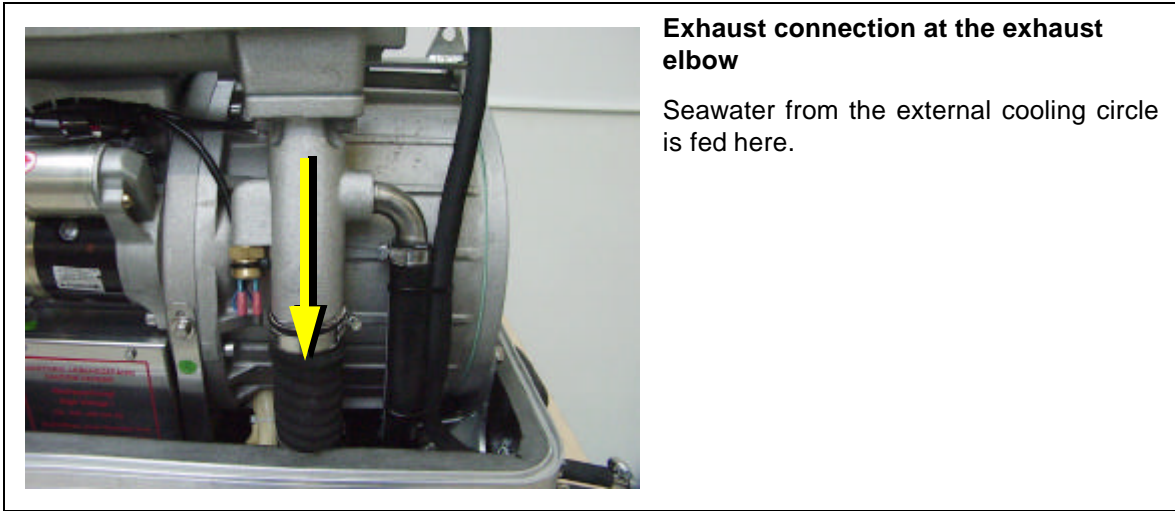

Fig. A.30: Exhaust connection

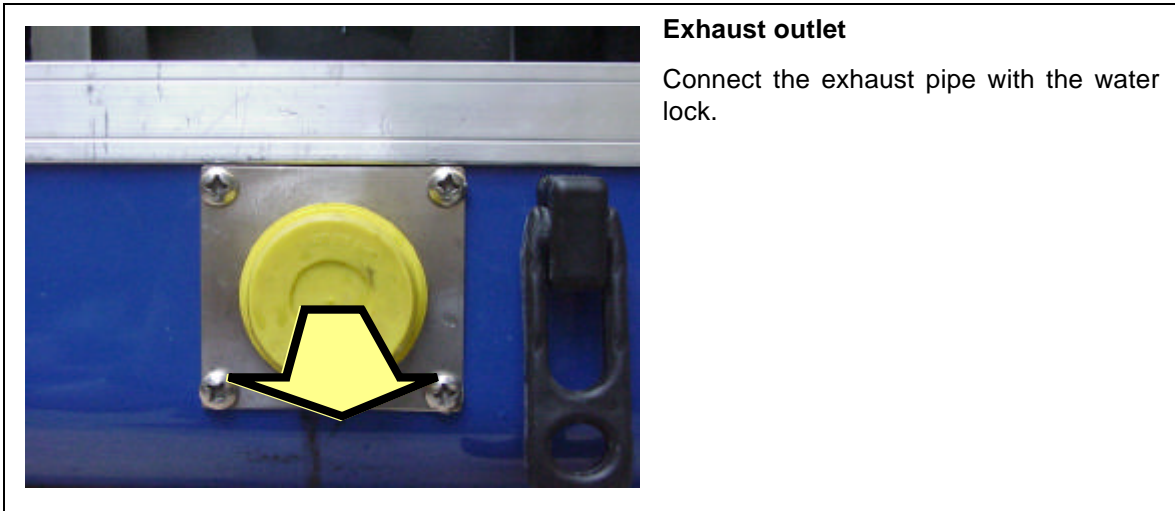

Fig. A.31: Exhaust outlet

A.2.6 Components of the electrical system

Connection starter battery

1. Cable for starter battery (plus)
2. Cable for starter battery (minus)

During the connection to the starter battery it must be always ensured that the contact is perfectly guaranteed.

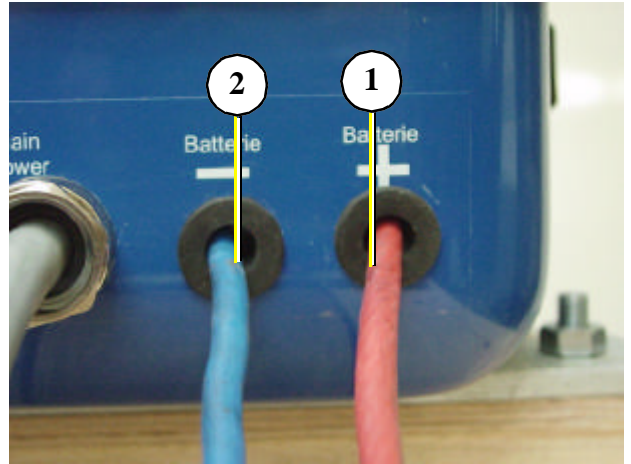

Fig. A.32: Cable for starter battery

Main power

At the front of the sound cover is also the withdrawal for the cable for the main power. Depending upon type of the generator are here also the cables for the connection of the external condensers (see for this the connection diagram for the AC-Control box!)

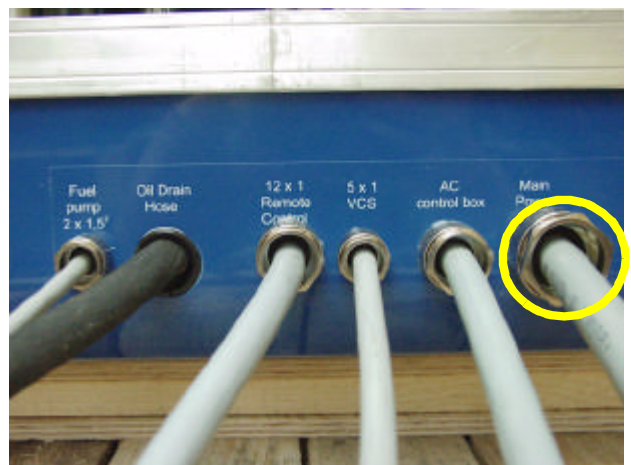

Fig. A.33: Main power

Electrical connections for control

At the front of the generator also all remaining cables for the electrical connections are depending upon type. The allocation of the connections result from the plan for the AC-Control box. See here:

1. Fuel pump
2. Remote control panel
3. VCS
4. AC-Control-Box

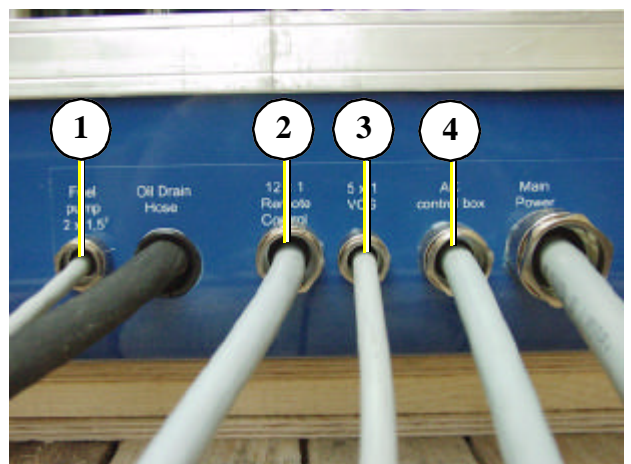

Fig. A.34: Elektrical connections

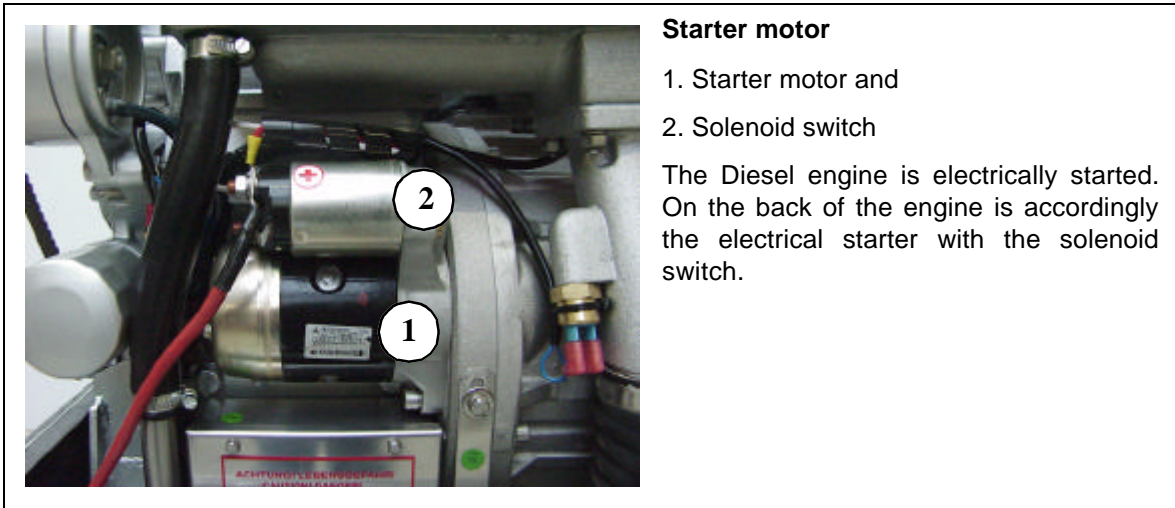

Fig. A.35: Starter motor

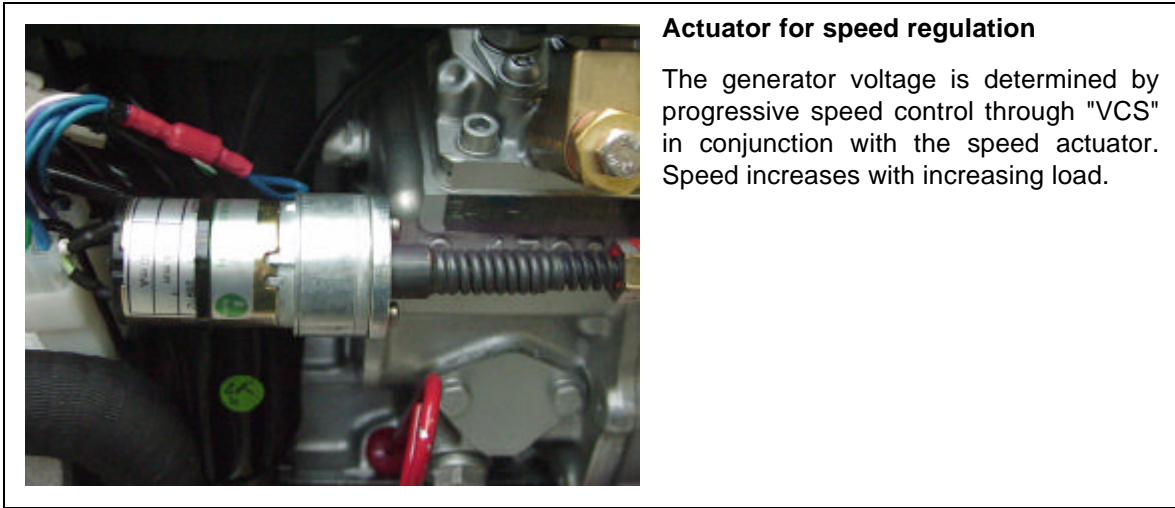

Fig. A.36: Actuator

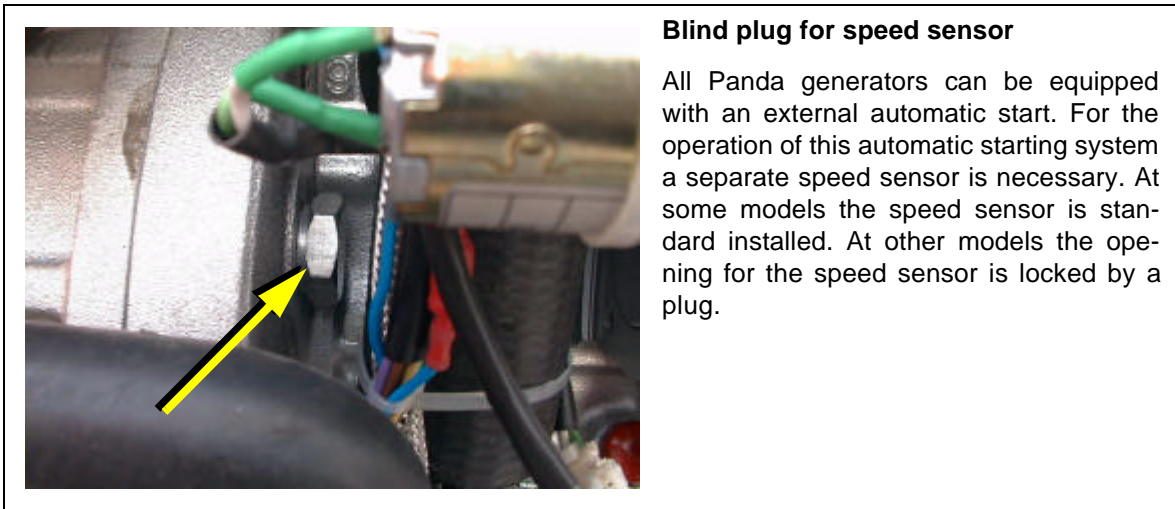

Fig. A.37: Blind plug

DC-alternator

All Panda generators from Panda 6.000 are provided with its own charge system for the 12V DC mains. This DC-alternator is powered over a v-belt together with the internal cooling water pump.

The 12V charge system may be used only for the generator-own starter battery.

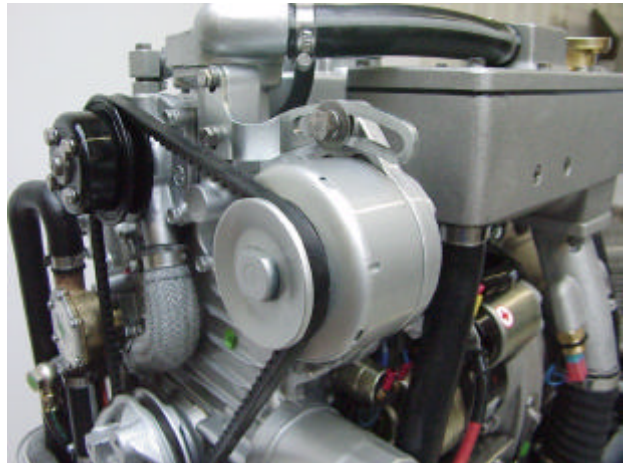

Fig. A.38: DC-alternator

Charge control for DC-alternator

The voltage regulator for the 12V DC-alternator is on the back of the air suction housing. The housing is formed for cooling purposes. The voltage regulator may not be covered from the outside. The surface must be accessible for the cooling.

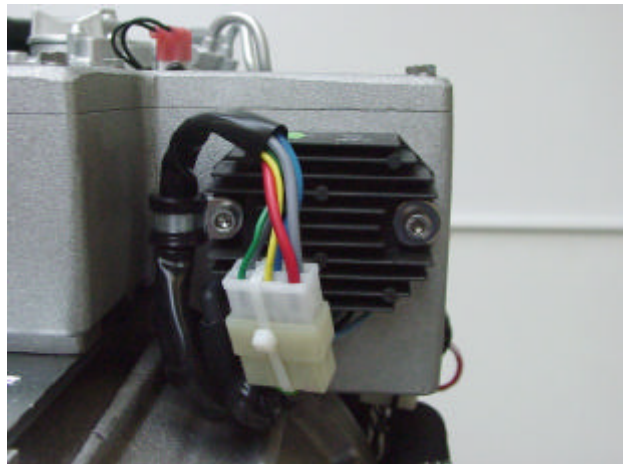

Fig. A.39: Charge control

Generator power terminal box

At the back of the generator is the generator power terminal box. In this box the electrical connection points of the AC generator are connected. Here is also the bridge for the protective grounding of the generator. The cover may only be removed, if it is guaranteed that the generator cannot be inadvertently started.



Fig. A.40: Generator power terminal box

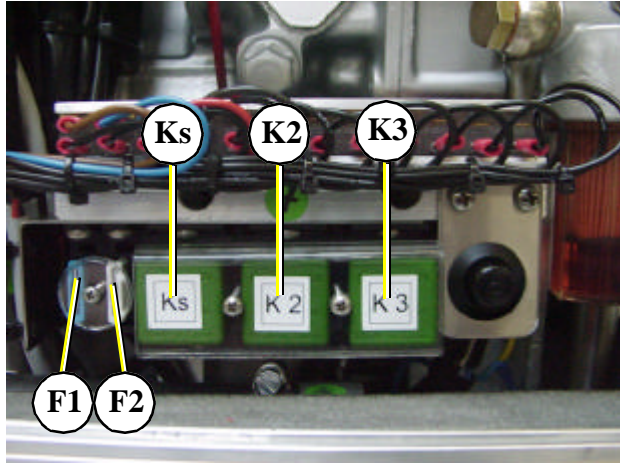

Terminal block for remote control cable with fuses and power relays

F1 fuse 15A for DC wiring
 F2 fuse 25A for starter relay
 Ks power relays for Starter
 K2 power relays for Glow plugs
 K3 power relays for Fuel pump

Fig. A.41: Terminal block

A.2.7 Sensors and switches for operating surveillance

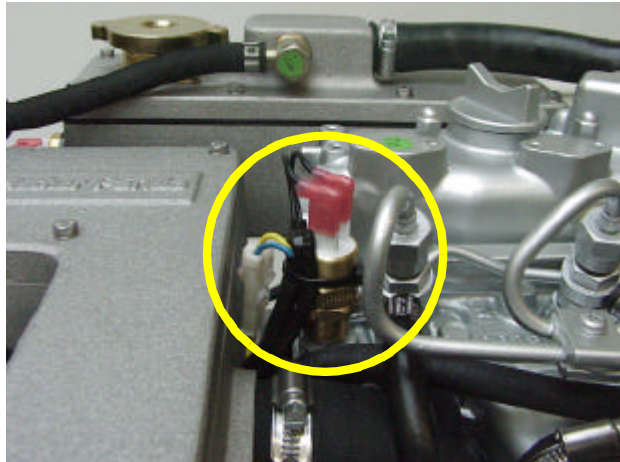

Thermo-switch at cylinder head

The thermo-switch at the cylinder head serves the monitoring of the generator temperature. All thermo-switches for the generators from Panda 6.000 upward are two-pole and laid out as "openers".

Fig. A.42: Thermo-switch at cylinder head

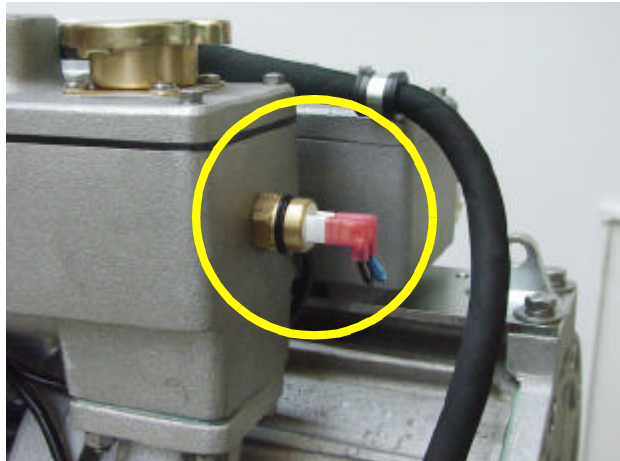

Thermo-switch at watercooled exhaust elbow

At some models a thermo-switch is also at the water-cooled exhaust elbow. This thermo-switch serves only for the additional monitoring. He is partly no more installed with the recent models.

Fig. A.43: Thermo-switch at exhaust elbow

Thermo-switch at exhaust connection

If the impeller pump drop out and delivers no more seawater, the exhaust connection becomes extremely hot.

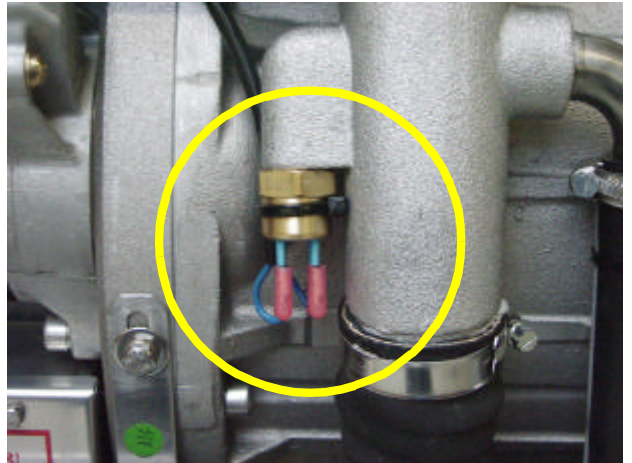

Fig. A.44: Thermo-switch at exhaust connection

Thermo-switch in the generator coil

1. Generator coil
2. Thermo-switch
3. Housing

For the protection of the generator coil there are two thermo-switches inside the coil, which are for inserted parallel and safety's sake independently from each other.

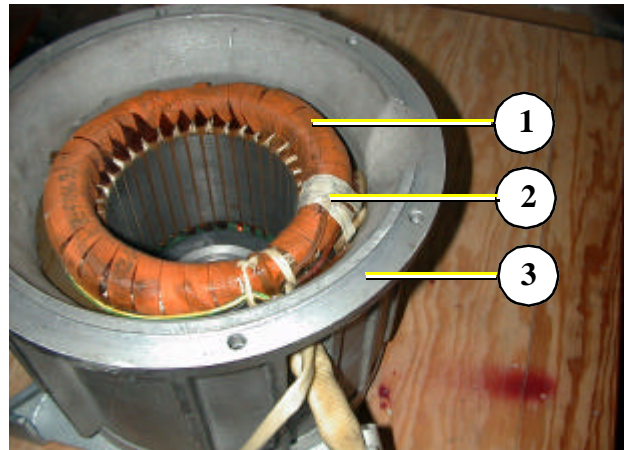

Fig. A.45: Coil thermo-switch

Thermo-switch in the generator coil

1. Generator coil
2. Thermo-switch
3. Housing

For the protection of the generator coil there are two thermo-switches inside the coil, which are for inserted parallel and safety's sake independently from each other.

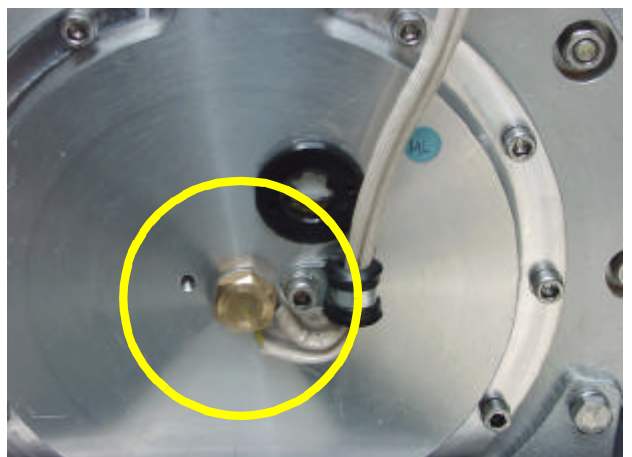
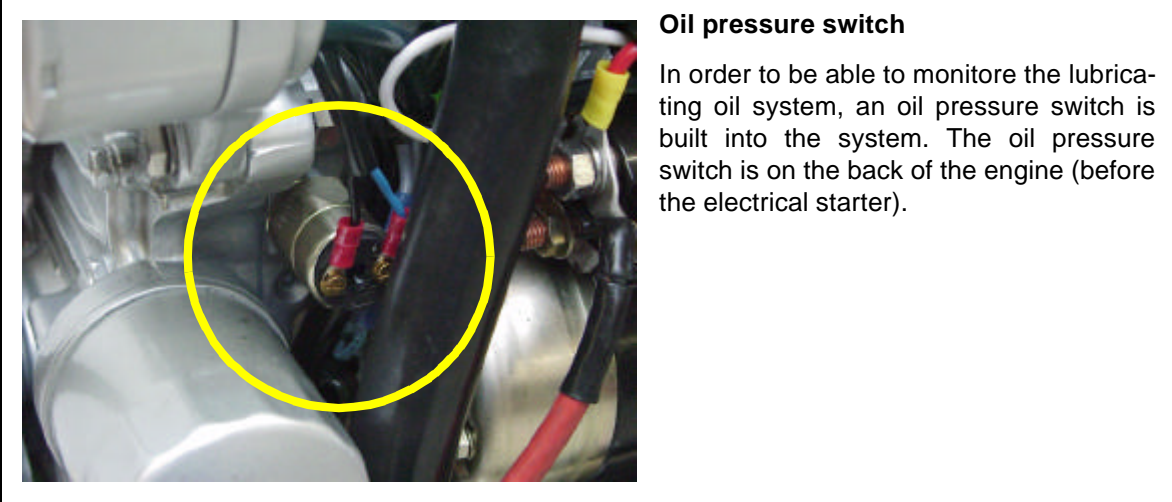

Fig. A.46: Coil thermo-switch



Oil pressure switch

In order to be able to monitor the lubricating oil system, an oil pressure switch is built into the system. The oil pressure switch is on the back of the engine (before the electrical starter).

Fig. A.47: Oil pressure switch

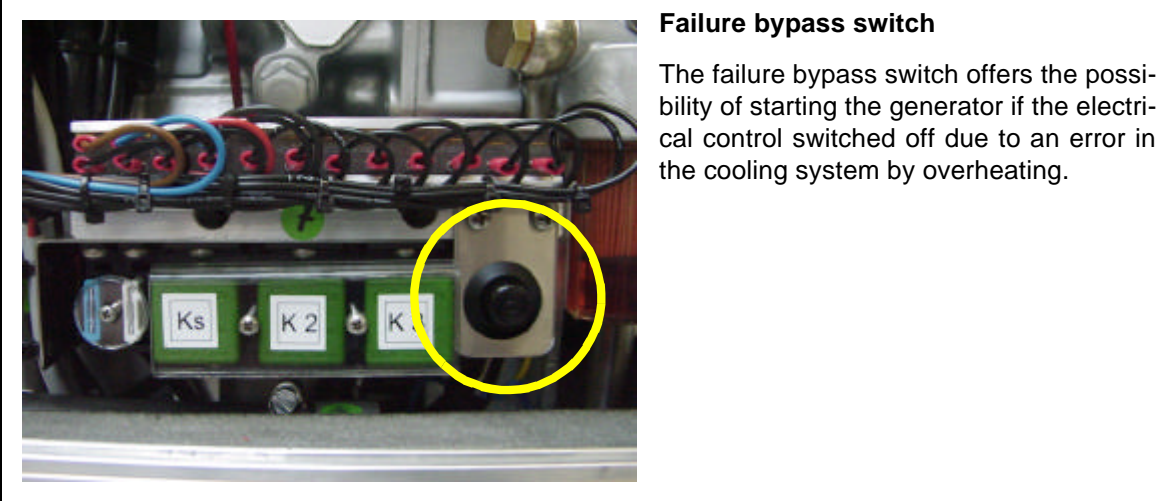

Failure bypass switch

The failure bypass switch offers the possibility of starting the generator if the electrical control switched off due to an error in the cooling system by overheating.

Fig. A.48: Failure bypass switch

A.2.8 Components of the oil circuit

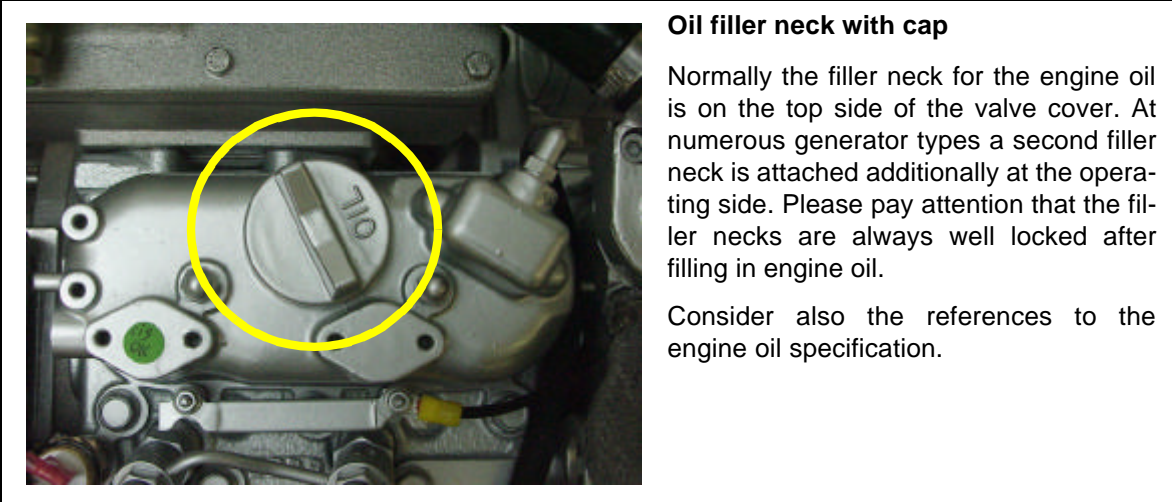

Oil filler neck with cap

Normally the filler neck for the engine oil is on the top side of the valve cover. At numerous generator types a second filler neck is attached additionally at the operating side. Please pay attention that the filler necks are always well locked after filling in engine oil.

Consider also the references to the engine oil specification.

Fig. A.49: Oil filler neck with cap

Oil dipstick

At the dipstick the permissible level is indicated by the markings "maximum" and "minimum". The engine oil should be never filled up beyond the maximum conditions.

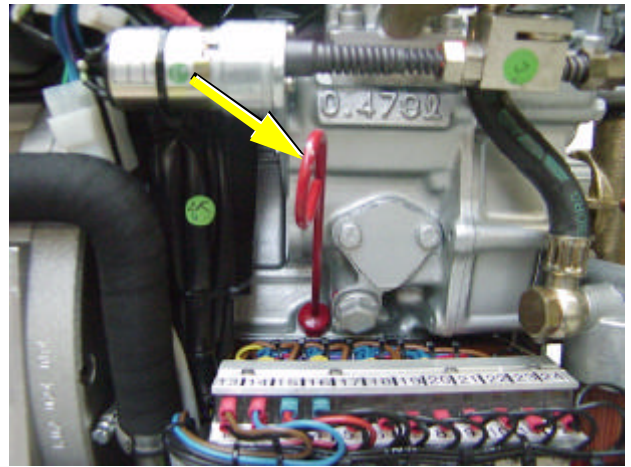

Fig. A.50: Oil dipstick

Oil filter

The oil filter should be exchanged with an oil change.

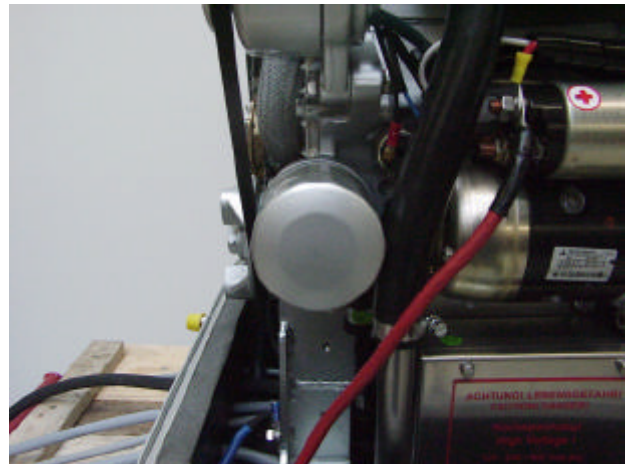

Fig. A.51: Oil filter

Oil drain hose

The Panda generator is equipped that the engine oil can be drained over an drain hose. The generator should be always installed therefore that a collecting basin can be set up deeply enough. If this is not possible, an electrical oil drain pump must be installed.

Note: Lubricating oil should be drained in the warm condition!

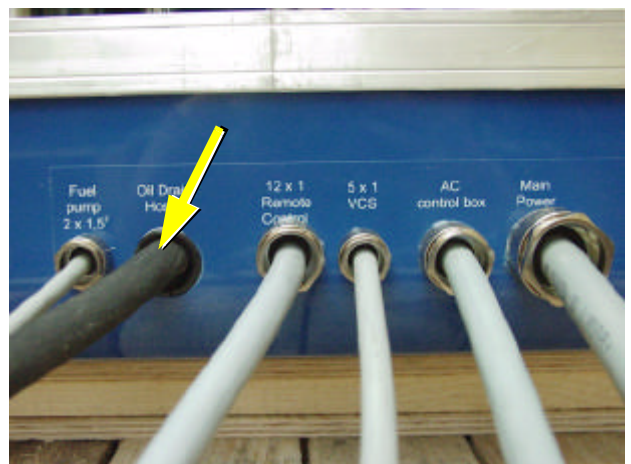

Fig. A.52: Oil drain hose

A.2.9 External components

AC-Control box



For the operation of the generator a AC-Control box is necessary. This AC-Control box contains electronics for the VCS control as well as different monitoring elements and the capacitors necessary for the excitation of the generator.

Fig. A.53: AC-Control box

AC-Control box



At operating the generator the operating voltage of 120/230 and/or 230/400V lies at the AC-Control box. It must be guaranteed that the generator cannot be inadvertently started, if the Control box is opened. For this reason the negative pole of the starter battery is to be disclamped with all work on the electrical system.

Fig. A.54: AC-Control box

Voltage control VCS

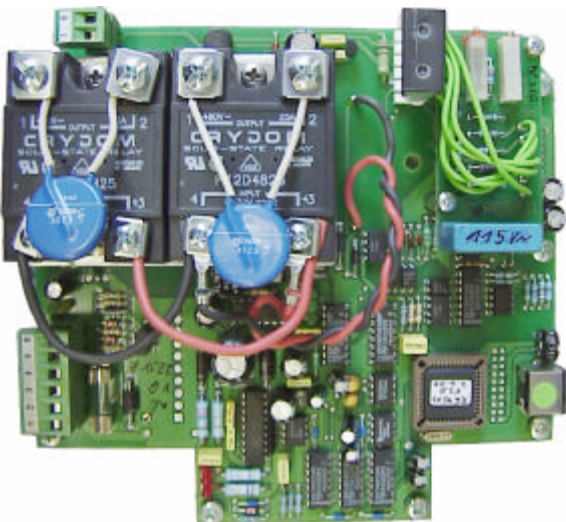

The figure shows the control printed board for the VCS voltage regulation. Over this control printed board the control signals are given for the actuator for speed regulation. On the VCS board are also adjustment possibilities for the control parameters.

Fig. A.55: Externe Kraftstoffpumpe

External fuel pump

The Panda generator is always supplied with an external, electrical (12 V of DC) fuel pump. The fuel pump must be always installed in the proximity of the tank. The electrical connections with the lead planned for it are before-installed at the generator. Since the suction height and the supply pressure are limited, it can be sometimes possible that for reinforcement a second pump must be installed.



Fig. A.56: External fuel pump

A.3 Operation manual

A.3.1 Preliminary remark

Pre-heating the diesel motor

The motor must be pre-heated, if the diesel motor is designed as a "pre-combustion chamber motor" for indirect fuel injection. A quick glow fitting is used for all Kubota-diesel motors. This glow fitting may only be used for a maximum of 20 seconds without a pause. A pre-glow period of 5 - 6 seconds suffices for ambient temperatures above 20°C (plus). For lower temperatures the preglow period should be increased.

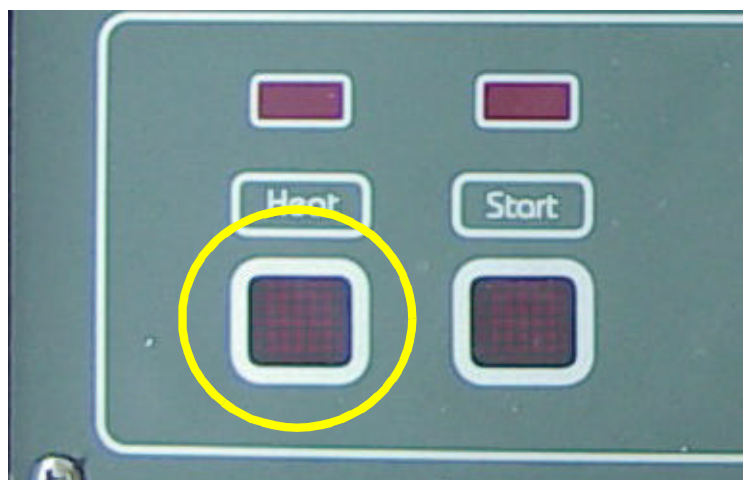

Tips regarding Starter Battery

Fischer Panda recommends normal starter battery use. If an aggregate is required for extreme winter conditions, then the starter battery capacity should be doubled. It is recommended that the starter battery be regularly charged by a suitable battery-charging device (i.e., at least every 2 Months). A correctly charged starter battery is necessary for low temperatures.

A.3.2 Daily routine checks before starting

1. Oil Level Control (ideal level: MAX).

ATTENTION! OIL PRESSURE CONTROL!

True, the diesel motor automatically switches off when there is a lack of oil, but it is very damaging for the motor, if the oil level drops to the lowest limit. Air can be sucked in suddenly when the boat rocks in heavy seas, if the oil level is at a minimum. This affects the grease in the bearings. It is therefore necessary to check the oil level daily before initially running the generator. The oil level must be topped up to the maximum level, if the level drops below the mark between maximum und minimum levels.

The oil level of the oil cooled bearing must be checked before every start - see flow glas at the generator front cover!



2. State of Cooling Water.

The external compensation tank should be filled up to a maximum of in a cold state. It is very important that large expansion area remains above the cooling water level.

3. Open Sea Cock for Cooling Water Intake.

For safety reasons, the seacock must be closed after the generator has been switched off. It should be re-opened before starting the generator.

4. Check Seawater Filter.

The seawater filter must be regularly checked and cleaned. The impeller fatigue increases, if residual affects the seawater intake.

5. Check all Hose Connections and Hose Clamps are Leakage.

Leaks at hose connections must be immediately repaired, especially the seawater impeller pump. It is certainly possible that the seawater impeller pump will produce leaks, depending upon the situation. (This can be caused by sand particles in the seawater etc.) In this case, immediately exchange the pump, because the dripping water will be sprayed by the belt pulley into the sound insulated casing and can quickly cause corrosion.

6. Check all electrical Lead Terminal Contacts are Firm.

This is especially the case with the temperature switch contacts, which automatically switch off the generator in case of faults. There is only safety if these systems are regularly checked, and these systems will protect the generator, when there is a fault.

7. Check the Motor and Generator Mounting Screws are Tight.

The mounting screws must be checked regularly to ensure the generator is safe. A visual check of these screws must be made, when the oil level is checked.

8. Switch the Land Electricity/Generator Switch to Zero before Starting or Switch Off all the Consumers.

The generator should only be started when all the consumers have been switched off. The excitation of the generator will be suppressed, if the generator is switched off with consumers connected, left for a while, or switched on with extra load, thus reducing the residual magnetism necessary for excitation of the generator to a minimum. In certain circumstances, this can lead to the generator being re-excited by means of a DC source. If the generator does not excitate itself when starting, then excitation by means of DC must be carried out again.

9. Check the Automatic Controls Functions and Oil Pressure.

Removing a cable end from the monitoring switch carries out this control test. The generator should then automatically switch off. Please adhere to the inspection timetable (see Checklist in the appendix).

A.3.3 Starting Generator

1. If necessary, open the fuel valve.
2. If necessary, close the main battery switch.
3. Check if all the consumers have been switched off.

The consumers are switched off, before the generator is switched off. The generator is not to be started with consumers connected. If necessary, the main switch or fuse should be switched off or the consumers should be individually switched off.

4. Press „ON“ button.

NOTE: If the red control light for oil pressure illuminates if the panel is switched on, this is an sign that the panel has an error. In this case the generator can not stop automatically if there is a disturbance.

Control light for "ON" Button must light up.

5. Pre-heat engine.

Pre-heating is necessary for every running temperature. Pre-heating is not necessary, only if the generator has just been run. The heating period should take at least 6 seconds, however, 20 seconds at the maximum. Heating must last for 20 seconds at a temperature of +5°C. If a second attempt is to be made, then a pause of at least 60 seconds is required.

The generator can be started with the assistance of a pre-heating device at temperatures as low as - 20°C. Please note that the generator can only be run at temperatures below -8°C with winter fuel and additional special additives.

6. Press „START“ button.

The electric starter may only be used for a maximum of 20 seconds. Thereafter, a pause of, at least, 60 seconds is required. If the aggregate does not immediately start, then the fuel intake should be checked to ensure it is flowing freely. (For temperatures below - 8°C check whether there is winter fuel)

7. Check circuit-voltmeter, to test whether there is AC-voltage and is within the tolerance rage (Frequency and voltage).

The AC voltage should be within a tolerance of ± 3 Volt without load at the nominal voltage. When running without load, the generator frequency should be 4% below the nominal voltage. The generator should be checked, before the consumers are switched on, if the current remain at this level.

8. Switch on consumers.

The consumers should only be switched on if the generator voltage is within the permissible range. Parallel connection of several consumers should be avoided, especially if there are consumers with electric motors, such as air-conditioning units in the system. In this case, the consumers must be connected Step by Step.

A.3.4 Stopping the Generator

1. Switch off consumers.
2. If the load is higher than 70% of the nominal load, the generator temperatures should be stabilised by switching off the consumers for at least 5 minutes.

At higher ambient temperatures (more than 25°C) the generator should always run for at least 5 minutes without load, before it is switched off, regardless of the load.

3. Press „OFF“ button and switch off the generator.
4. Activate additional switches (Battery switch, fuel stop valve etc.).

NOTE: Never switch off the battery until the generator has stopped.

5. If necessary, close sea cock.

A.3.5 Starting the Generator by a „Failure bypass switch“

There is a "pressure switch" on the operation unit. Faults (e.g. caused by overheating) can be manually overcome by means of this switch. The generator can be started by using the remote control panel. The operating temperature can be reduced for a short period of time (without stress of course), so that the fault switch returns to the original position should overheating cause the generator to shut down because of overheating.

ATTENTION: - Before using the failure bypass switch, it is important to check the oil level, since the oil gauge is deactivated by the switch. For a further reason it is important to switch off the generator electrical load before the generator is shut down:

Before stopping the generator it is highly recommended that electrical devices (e.g. refrigerating compressors, air conditioning compressors etc) are switched off, because the voltage drops as the rotational speed (rpm) decreases as the engine comes to a halt.

(Also see information regarding voltage control with automatic shut-off for protection of consumers when over or undervoltage occurs).

This is also the case when the generator is started when consumers are switched on.

Normally the generator will no longer excitate if a certain amount of base load is stepped up. The electrical load should also be shut-off before starting the generator.

If started under electrical load, the engine will still run but the generator will not generate the proper voltage (or even no voltage) since the stator windings do not have the chance to reach full excitation. Electrical units which are switched on in this condition could possibly be damaged (special caution should be practised with electric motors to avoid burnout).

